

Oblique™ Weatherboard 14mm Horizontal Installation

Technical Specification
June 2024 New Zealand





We value your feedback!

To continue with the development of our products and systems, we value your input. Please send any suggestions, including your name, contact details, and relevant sketches to:

Ask James Hardie™
literaturefeedback@jameshardie.co.nz

Make sure your information is up to date

When specifying or installing Hardie™ fibre cement products, ensure that you have the current manual. Additional installation information, warranties and warnings are available at www.jameshardie.co.nz or **Ask James Hardie™** on **0800 808 868**.

Contents

1	Product Overview	4	6	Installation	15
1.1	Product Information	4	6.1	Fastener	15
1.2	Manufacturing and Classification	4	6.2	Framing	17
1.3	Components and Accessories	5	6.3	Flexible underlay or HomeRAB™ Pre-Cladding	18
2	Application and Scope	7	6.4	Intermediate Support for Flexible Underlays	18
2.1	Application	7	6.5	Rigid Air Barrier	18
2.2	Scope	7	6.6	Flashings	18
2.3	Details	7	6.7	Cavity Closure/Vent Strip	19
2.4	Specific Design	7	6.8	Cavity Battens	19
3	Compliance	8	6.9	Joints	19
4	Design	8	7	Finishes	20
4.1	Responsibility	8	7.1	Preparation	20
4.2	Clearances	9	7.2	Painting	20
4.3	Moisture Management	9	7.3	Flexible Sealant	20
4.4	Structure	9	8	Care and Maintenance	21
4.5	Wind Pressures	10	9	Details	22
4.6	Structural Bracing	10	Product Warranty	66	
4.7	Energy Efficiency	10			
4.8	Fire Rated Walls	10			
4.9	Control of External Fire Spread	10			
4.10	Durability	11			
4.11	Alpine Regions	11			
5	Safe Working Practices	12			
5.1	Storage and Delivery	14			
5.2	Tips for Safe and Easy Handling of Oblique™ Weatherboard	15			

1 Product Overview

1.1 Product Information

Oblique™ Weatherboard installed as per this specification gives a rusticated profile weatherboard appearance. Oblique™ Weatherboard can be fixed to timber framed external walls. A wide range of colours can be used varying from light to dark. Oblique™ Weatherboard is available in 200mm or 300mm wide x 4200mm or 3000mm lengths and is 14mm thick.

Table 1

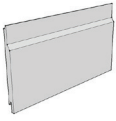
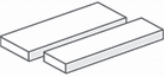
Oblique™ Weatherboard information					
Product	Description	Size (mm)			Code
		Thickness	Length	Width	
	Oblique™ Weatherboard A 14mm profiled weatherboard for residential cladding. Factory sealed on all six sides. Each weatherboard has a manila white colour primer applied on its face, which accepts a wide range of paint finishes.	14	3000	200 300	405520 405521
			4200	200 300	
	Hardie™ Axent™ Trim Hardie™ Axent™ Trim is a 19mm thick, pre-primed fibre cement product available in two widths. For use as decorative trims around openings and external corners.	19	3000	70 89	405257 405258

Note: All dimensions and masses provided are approximate only and subject to manufacturing tolerances.

Oblique™ Weatherboard is manufactured in 14mm thickness and has a mass of 16kg/m².

Oblique™ Weatherboard is defined as a Light Weight Wall Cladding (not exceeding 30kg/m²) as per NZS 3604.

1.2 Manufacturing and Classification

Oblique™ Weatherboard is an advanced lightweight cement composite cladding manufactured using James Hardie formulation. Basic composition is Portland cement, ground sand, cellulose fibre, water and proprietary additives. The product is easily identified by the name 'Oblique Weatherboard'.

Hardie™ Axent™ Trim is an advanced lightweight cement composite cladding manufactured using a basic composition of Portland cement, ground sand, cellulose fibre, water and proprietary additives. The product is easily identified by the name 'Hardie Axent' printed on the back.

Oblique™ Weatherboard and Hardie™ Axent™ Trim products are manufactured in Australia to Australian/New Zealand Standard AS/NZS 2908.2 'Cellulose-Cement Products' (ISO 8336 'Fibre-Cement Flat Sheet').

Oblique™ Weatherboard and Hardie™ Axent™ Trim products are classified Type A, Category 2 in accordance with AS/NZS 2908.2 "Cellulose-Cement Products".







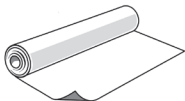

For Safety Data Sheets (SDS) visit www.jameshardie.co.nz or **Ask James Hardie™** on **0800 808 868**.

1.3 Components and Accessories

Table 2

Accessories/tools supplied by James Hardie			
Accessories	Description	Size	Code
	Hardie™ 14mm Aluminium Trimline Joint Flashing Aluminium extrusion used behind cladding at horizontal and vertical joints.	3000mm long	305827
	Trimline Horizontal Jointer A jointer to cover the butt joint of Hardie™ 14mm Trimline Joint Flashing	100mm long	305871
	Trimline External Corner Jointer Joins Hardie™ 14mm Trimline Joint Flashing at an external corner	55 x 55mm	305870
	Trimline Internal Corner Jointer Joins Hardie™ 14mm Trimline Joint Flashing at an internal corner	60 x 60mm	305872
	Hardie™ 14mm Vertical Flashing Stop Aluminium Aluminium extrusion used behind cladding at vertical joints.	3000mm long	305507
	Hardie™ Aluminium Internal Corner 'W' Mould Anodised aluminium extrusion used to create internal corners.	3000mm long 4000mm long	306262 306180
	Hardie™ 14mm Aluminium External Box Corner Anodised aluminium extrusion used to create external corners.	3000mm long 4000mm long	306261 305823
	Hardie™ 14mm Aluminium Jamb Flashing Aluminium moulding used beside window opening to end butt the Oblique™ Weatherboard.	3000mm long	305430
	Hardie™ 28mm Aluminium Cavity Closer Aluminium moulding used as vermin proofing.	3000mm long	305431
	uPVC Vent Strip PVC moulding used as vermin proofing.	3000mm long	302490
	Oblique™ 14mm Plug To fill recess in Oblique™ Weatherboard 14mm		306154
Tools			
	Hardie™ Blade Saw Blade Diamond tip fibre cement circular saw blade. Spacers not included.	184mm 254mm	300660 303375

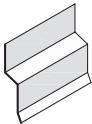
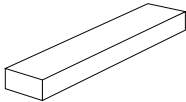
Table 3

Accessories/tools not supplied by James Hardie	
<p>James Hardie recommends the following products for use in conjunction with Oblique™ Weatherboard and HomeRAB™ Pre-Cladding/RAB™ Board. James Hardie does not supply these products and does not provide a warranty for their use. Please contact component manufacturer for information on their warranties and further information on their products.</p>	
Product	Description
	<p>Flexible underlay Must comply with Table 23 of E2/AS1.</p>
	<p>Flexible window opening flashing tape A flexible self-adhesive tape used in preparation of a window. Refer to the window installation section in this manual for more information. e.g. Protecto® or Super-Stick Building Tape® by Marshall Innovations or 3M™ All Weather Flashing Tape 8067 by 3M™ Marshall Innovations: 0800 776 9727 3M™: 0800 474 787</p>
	<p>Flexible sealant Required to seal the vertical joints. Bostik® Seal N Flex-1™, Sikaflex® AT Facade, Sikaflex® MS or similar.</p>
	<p>65 x 2.87mm 'D' head nail or 65 x 2.87 RoundDrive nail (ring shank hot dipped galvanised/stainless steel) For fixing Oblique™ Weatherboard.</p>
	<p>75 x 3.06mm 'D' head nail or 75 x 3.15 RoundDrive nail (hot dipped galvanised or ring shank stainless steel) For fixing Oblique™ Weatherboard.</p>
	<p>40 x 2.8mm or longer Hardie™ Flex nail For fixing timber cavity battens and aluminium flashings.</p>
	<p>Head flashing Required over window heads to be supplied by window installer. Material must comply with Table 20 and 21 of E2/AS1.</p>
	<p>Timber cavity batten H3.1 minimum treated Timber cavity batten the cladding is fixed over.</p>
	<p>Exterior grade filler CRC® ADOS® Builders Fill or similar two part filler to fill over nail holes</p>
	<p>Penetration Seals Thermakraft™: 0800 806 595 Marshall Innovations: 0800 776 9727</p>

2 Application and Scope

2.1 Application

Oblique™ Weatherboard can be fixed to either timber or lightweight steel-framed external walls.

For fixing to a steel frame, Ask James Hardie™ on 0800 808 868 for specific requirements, or refer to the Steel Frame Technical Supplement by James Hardie about the installation of Oblique™ Weatherboard to steel frame.

Specifiers

If you are a specifier or other responsible party for a project, ensure that the information in this document is appropriate for the application you are planning and that you undertake specific design and detailing for areas which fall outside the scope of these specifications.

Installers

If you are an installer, ensure that you follow the design, moisture management principles, associated figures and material selection provided by the designer and this Technical Specification. All of the details provided in this document must be read in conjunction with the project specification.

2.2 Scope

This specification covers the installation of Oblique™ Weatherboard within the following scope:

- The Oblique™ Weatherboard must be installed horizontally
- An external wall structure that complies with the NZBC for an existing building or new building where the designer and/or installer has established that the external wall frame is suitable for the cladding installation
- In all wind zones up to a design wind pressure of 3.2kPa (ULS) up to 25m of the building height. In wind zones greater than Very High (VH), a rigid air barrier must be used

Refer to Oblique™ Weatherboard Vertical Installation technical specification when installing vertically

2.3 Details

Various typical Oblique™ Weatherboard horizontal construction details are provided in the Details section of this document. These details are available in dwg, dxf, jpg and pdf file format and can be downloaded from our website at www.jameshardie.co.nz.

All dimensions shown are in millimetres unless noted otherwise.

2.4 Specific Design

For use of the Oblique™ Weatherboard on a specific design project that is outside the scope of this literature, the designer, architect or engineer must ensure that applicable clauses of the NZBC have been considered and a specific design has been undertaken.

3 Compliance

Oblique™ Weatherboard installed in accordance with this specification has been tested to demonstrate compliance with clauses E2, B1, B2 and F2 of the NZBC.

When installed in accordance with the conditions of CodeMark number GM-CM30147 Oblique™ Weatherboard complies with all relevant requirements of the NZBC. Please refer to www.building.govt.nz or www.jameshardie.co.nz for a copy of the certificate.



Oblique™ Weatherboard Horizontal Installation has a BRANZ Appraisal number 1231 (2022) to demonstrate compliance with the requirements of the NZBC. Please refer to our website www.jameshardie.co.nz for a copy of the BRANZ appraisal.



4 Design

4.1 Responsibility

The specifier or other party responsible for the project must ensure that the information and details in this specification are appropriate for the intended application and that additional detailing is performed for specific design or any areas that fall outside the scope of this technical specification. For applications outside the scope of this literature and details which are not provided herein, the architect, designer or engineer must undertake specific design. It should be ensured that the intent of their design meets the requirements of the NZBC.

All New Zealand Standards referenced in this document are current editions and must be complied with.

Make sure your information is up to date

When specifying or installing products by James Hardie, ensure that you have the current manual. Additional installation information, warranties and warnings are available at www.jameshardie.co.nz or Ask James Hardie™ on 0800 808 868.

James Hardie conducts stringent quality checks to ensure that any product manufactured falls within our quality spectrum. It is the responsibility of the builder to ensure that the product meets aesthetic requirements before installation. James Hardie will not be responsible for rectifying obvious aesthetic surface variations following installation.

4.2 Clearances

The clearance between the bottom edge of the cladding and paved/unpaved ground must comply with section 9.1.3 of E2/AS1. The finished floor level must also comply with these requirements. These clearances must be maintained throughout the life of the building.

Oblique™ Weatherboard must overhang the bottom plate by a minimum of 50mm, as required by E2/AS1.

Oblique™ Weatherboard must maintain a minimum clearance of 100mm from paved ground and 175mm from unpaved ground.

On roofs and decks, the minimum clearance must be 50mm.

Do not install external cladding such that it may remain in contact with water or ground. Refer to Figures 5 and 6.

4.3 Moisture Management

It is the responsibility of the specifier to identify moisture related risks associated with any particular building design.

Wall construction design must effectively manage moisture, considering both interior and exterior environments of the building, particularly in buildings that have a higher risk of wind driven rain penetration. The building should also be ventilated sufficiently to control moisture accumulation due to condensation, especially in artificially cooled/heated buildings.

Walls must include those provisions as required by the NZBC Acceptable Solution E2/AS1. In addition, all wall openings, penetrations, junctions, connections, window sills, heads and jambs must incorporate appropriate flashings for waterproofing. Other materials, components and installation methods used to manage moisture in external walls, must comply with the requirements of relevant standards and the NZBC. For further guidance on designing for weather tightness, refer to BRANZ Ltd, and the Ministry of Business, Innovation and Employment (MBIE) updates on the following websites respectively, www.branz.co.nz and www.building.govt.nz.

In addition, the following issues must also be considered:

- Sealant must be installed where detailed in this literature
- For buildings within the scope of E2/AS1, a drained horizontal joint must be provided after two floors as a minimum. For buildings more than 10m high, a drained horizontal joint must be provided at each floor to accommodate the interstory deflection
- The installation of smoke chimneys, pipe penetrations and other fixtures etc. must not track moisture into the wall or restrict the drainage of moisture to the exterior

4.4 Structure

4.4.1 Timber Framing

Timber framed buildings must either be in accordance with NZS 3604 (Timber-framed buildings) or designed as per specific engineering design (SED).

For timber frame walls longer than 12m, it is best practice to allow for construction joints to accommodate movements generated due to timber shrinkage or deflections etc.

4.4.2 Dimensions

A 90 x 45mm minimum framing size is required.

4.4.3 Structural Grade

Timber grade used must be in accordance with timber grades specified in NZS 3604.

4.4.4 Durability

As per the requirements of the NZS 3602 (Timber and Wood-Based Products for use in Buildings) the timber framing used for external frames must be treated to H1.2 as a minimum. Higher treatments may be used but check the compatibility of other materials to be used with the treatment.

Refer to Clause B2/AS1 for further information regarding the durability of building materials. Framing must be handled and installed in accordance with project technical specifications. Framing must meet the allowable moisture contents as per the NZS 3602 .

4.5 Wind Pressures

Oblique™ Weatherboard is suitable for use in wind zones up to and including EH as defined in NZS 3604.

Oblique™ Weatherboard is also suitable in specific design projects up to wind pressures of 3.2kPa ULS.

4.6 Structural Bracing

Oblique™ Weatherboard installed as per this specification cannot be used to achieve any structural bracing. However, bracing can be achieved by using a HomeRAB™ Pre-Cladding/RAB™ Board installed direct to framing instead of a flexible underlay or by using Villaboard™ Lining bracing system on the internal face of the wall. Refer to the Bracing Design Manual by James Hardie for further information.

4.7 Energy Efficiency

External walls constructed as per this technical specification, using Oblique™ Weatherboard, must use suitable bulk insulation to meet the minimum thermal insulation requirements as per Clause H1/AS1 'Energy Efficiency' of the NZBC.

4.8 Fire Rated Walls

Oblique™ Weatherboard when fixed over timber cavity battens to external walls can achieve fire ratings up to 60/60/60 to comply with Clause C/AS1 and C/AS2 of the NZBC, when the walls are constructed in accordance with the current Fire and Acoustic Design Manual by James Hardie.

Nogs in fire rated walls must be at 800mm centres maximum.

Oblique™ Weatherboard is classified as a 'non-combustible' material suitable for use on walls close to a boundary.

Note: 300mm Oblique™ Weatherboards to have 2 nails. Refer to Figure 4.

4.9 Control of External Fire Spread

Oblique™ Weatherboard material is classified as 'Type-A' as per Table C1.3 when tested to the requirements of Appendix C7.1.1 (b) of C/AS2 of the NZBC and is suitable for use where 'Non Combustible Material' or ' Limited Combustibility Material' is required for use in buildings located anywhere in relation to the relevant boundary for building within the scope of C/AS1 or C/AS2.

- Where the upper floors contain sleeping uses or other property, a horizontal flashed joint must be provided to block the top of lower cavity at intervals of no greater than 3.5m vertical height
- On buildings greater than 10m in height, a RAB™ Board must be used

4.10 Durability

Oblique™ Weatherboard installed and maintained as per this technical specification will meet the durability requirement for cladding as per the NZBC clause B2 Durability.

Oblique™ Weatherboard is resistant to permanent moisture induced deterioration (rotting) and meets the requirements of the following tests in accordance with the AS/NZS 2908.2:

- Heat Rain (Clause 6.5)
- Water Permeability (Clause 8.2.2)
- Warm Water (Clause 8.2.4)
- Soak Dry (Clause 8.2.5)

4.11 Alpine Regions

In regions subject to freeze/thaw conditions, Oblique™ Weatherboard must not be in direct contact with snow or ice build up for extended periods, e.g. external walls in alpine regions must be protected where snowdrifts over winter are expected.

These products have been tested in accordance with AS/NZS 2908.2 Clause 8.2.3.

5 Safe Working Practices

WARNING - DO NOT BREATHE DUST AND CUT ONLY IN WELL VENTILATED AREA

Hardie™ fibre cement products contain sand, a source of respirable crystalline silica may cause cancer if dust from product is inhaled. Causes damage to lungs and respiratory system through prolonged or repeated inhalation of dust from product.

Intact fibre cement products are not expected to result in any adverse toxic effects. The hazard associated with fibre cement arises from the respirable crystalline silica present in dust generated by activities such as cutting, rebating, drilling, routing, sawing, crushing, or otherwise abrading fibre cement, and when cleaning up, disposing of or moving dust.

When doing any of these activities in a manner that generates dust, follow James Hardie instructions and best practices to reduce or limit the release of dust.

If using a dust mask or respirator, use an AS/NZS1716 P1 filter and refer to Australian/New Zealand Standard 1715:2009 Selection, Use and Maintenance of Respiratory Protective Equipment for more extensive guidance and more options for selecting respirators for workplaces. For further information, refer to our installation instructions and Safety Data Sheets available at www.jameshardie.co.nz.

FAILURE TO ADHERE TO OUR WARNINGS, SAFETY DATA SHEETS, AND INSTALLATION INSTRUCTIONS MAY LEAD TO SERIOUS PERSONAL INJURY OR DEATH.

Crystalline Silica is

- Commonly known as sand or quartz
- Found in many building products e.g. concrete, bricks, grout, wallboard, ceramic tiles, and all fibre cement materials

Why is Crystalline Silica a health hazard?

- Silica can be breathed deep into the lungs when present in the air as a very fine (respirable) dust
- Exposure to silica dust without taking the appropriate safety measures to minimise the amount being breathed in, can lead to a potentially fatal lung disease – silicosis – and has also been linked with other diseases including cancer. Some studies suggest that smoking may increase these risks
- The most hazardous dust is the dust you cannot see!

When is Crystalline Silica a health hazard?

- It's dangerous to health if safety protocols to control dust are not followed when cutting, drilling or rebating a product containing crystalline silica and when cleaning up
- Products containing silica are harmless if intact (e.g. an un-cut sheet of wall board)

Avoid breathing in crystalline silica dust

Safe working practices

- ✗ NEVER use a power saw indoors or in a poorly ventilated area
- ✗ NEVER dry sweep
- ✓ ALWAYS use M Class or higher vacuum or damp down dust before sweeping up
- ✗ NEVER use grinders
- ✓ ALWAYS use a dust reducing circular saw equipped with a sawblade specifically designed to minimise dust creation when cutting fibre cement – preferably a sawblade that carries the Hardie™ Blade name or one with at least equivalent performance – connected to an M Class or higher vacuum
- ✓ Before cutting warn others in the area to avoid dust
- ✓ ALWAYS follow tool manufacturers' safety recommendations
- ✓ ALWAYS expose only the minimum required depth of blade for the thickness of fibre cement to be cut
- ✓ ALWAYS wear a properly-fitted, approved dust mask or respirator P1 or higher in accordance with applicable government regulations and manufacturer instructions
- ✓ Consider rotating personnel across cutting tasks to further limit respirable silica exposures.

When cutting

- ✓ Work outdoors only
- ✓ Make sure you work in a well ventilated area
- ✓ Position cutting station so wind will blow dust away from yourself and others in the working area
- ✓ Rotate employees across cutting task over duration of shift
- ✓ Cut products with a Hardie™ Blade Saw Blade (or equivalent) and a dust reducing circular saw connected to a M Class or higher vacuum
- ✓ When sawing, sanding, rebating, drilling or machining fibre cement products, always:
 - Wear your P1 or higher (correctly fitted in accordance with manufacturers' instructions), ask others to do the same.
 - Keep persons on site at least 2 metres and as far as practicable away from the cutting station while the saw is in operation
 - If you are not clean shaven, then use a powered air respirator with a loose fitting head top
 - Wear safety glasses
 - Wear hearing protection
- ✓ Make sure you clean up BUT never dry sweep. Always hose down with water/wet wipe or use an M Class or higher vacuum

If concern still exists about exposure levels or you do not comply with the above practices, you should always consult a qualified industrial hygienist or contact James Hardie for further information.

Working Instructions

Hardie™ Blade Saw Blade

The Hardie™ Blade Saw Blade used with a dust-reducing saw is ideal for fast, clean cutting of Hardie™ fibre cement products. A dust-reducing saw uses a dust collector connected to a M Class or higher vacuum. When sawing, clamp a straight edge to the sheet as a guide and run the saw base plate along the straight edge when making the cut.

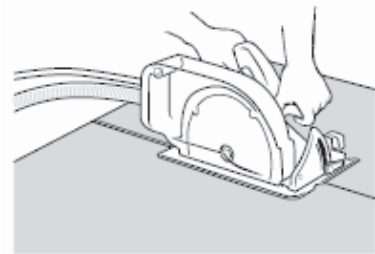

Hole-Forming

For smooth clean cut circular holes:

- Mark the centre of the hole on the sheet
- Pre-drill a 'pilot' hole
- Using the pilot hole as a guide, cut the hole to the appropriate diameter with a hole saw fitted to a heavy duty electric drill



For irregular holes:

- Small rectangular or circular holes can be cut by drilling a series of small holes around the perimeter of the hole then tapping out the waste piece from the sheet face
- Tap carefully to avoid damage to sheets, ensuring that the sheet edges are properly supported

5.1 Storage and Delivery

Keeping products and people safe

Off loading

- ✓ Hardie™ fibre cement products should be off-loaded carefully by hand or by forklift
- ✓ Hardie™ fibre cement products should not be rolled or dumped off a truck during the delivery to the jobsite

Storage

Hardie™ fibre cement products should be stored:

- ✓ In their original packaging
- ✓ Under cover where possible or otherwise protected with a waterproof covering to keep products dry
- ✓ Off the ground – either on a pallet or adequately supported on timber or other spacers
- ✓ Flat so as to minimise bending

Hardie™ fibre cement products must not be stored:

- ✗ Directly on the ground
- ✗ In the open air exposed to the elements

James Hardie is not responsible for damage due to improper storage and handling.

5.2 Tips for Safe and Easy Handling of Oblique™ Weatherboard

- ✗ Do not lift planked products flat and in the middle
- ✓ Carry the products on the edge
- ✓ If only one person is carrying the product, hold it in the middle and spread arms apart to better support the product
- ✓ If two people are carrying the plank, hold it near each end and on edge
- ✓ Exercise care when handling weatherboard products to avoid damaging the edges/corners

6 Installation

Oblique™ Weatherboard must be installed horizontally using the cavity construction method as per the details and information published in this document.

Oblique™ Weatherboard must be kept under cover whilst in storage or at sites and they must be dry at the time of their installation. All site-cut weatherboard edges must be sealed with Dulux® 1 Step, Acraprime® 501/1, Resene® Quick Dry or a similar sealer compatible with the finish coat before installation.

Oblique™ Weatherboard must be fully supported and fixed through timber cavity battens. Ensure that cladding is hard against the battens to avoid drumminess.

To achieve best aesthetic results it is recommended to position the vertical jointer by the corner of openings or coinciding with the centre line of openings.

This technical specification only covers the horizontal installation of Oblique™ Weatherboard. Refer to the Oblique™ Weatherboard Vertical Installation Technical Specification for vertical installation.

6.1 Fastener

6.1.1 Fastener – Size and Layout

Oblique™ Weatherboard must be fixed horizontally to framing using fixings as specified in Tables 4 and 5 on the next page and follow the edge distance required for nails as shown in the details.

Table 4

Oblique™ Weatherboard 200mm			
Cavity Construction	Wind Zone	Fixing	Fastener Type
Over flexible underlay	Up to and including VH wind zone	Fix one nail 100mm from bottom edge of board per board/per stud. Refer to Figure 3	65 x 2.87mm D head or 65 x 2.87mm RounDrive ring shank nails
Over HomeRAB™ Pre-Cladding/RAB™ Board	Up to and including VH wind zone	Fix one nail 100mm from bottom edge of board per board/per stud. Refer to Figure 3	75 x 3.06mm D head or 75 x 3.15mm RounDrive ring shank nails
Over RAB™ Board	Above VH wind zone up to 3.2kPa (ULS) wind pressures with stud spacing at 400mm centres		

Table 5

Oblique™ Weatherboard 300mm			
Cavity Construction	Wind Zone	Fixing	Fastener Type
Over flexible underlay	Up to and including VH wind zone	Fix one nail 150mm from bottom edge of board per board/per stud. Refer to Figure 3	65 x 2.87mm D head or 65 x 2.87mm RounDrive ring shank nails
Over HomeRAB™ Pre-Cladding/RAB™ Board	Up to and including VH wind zone	Fix one nail 150mm from bottom edge of board per board/per stud. Refer to Figure 3	75 x 3.06mm D head or 75 x 3.15mm RounDrive ring shank nails
Over RAB™ Board	Up to and including EH wind zone and SED projects with studs at 400mm centres maximum	Fix one nail 150mm from bottom edge of board per board/per stud. Refer to Figure 3	
Over RAB™ Board	Up to and including EH wind zone and SED projects with studs at 600mm centres maximum	Fix two nails 80mm from bottom and top edge of board per board/per stud. Refer to Figure 4	

- When fixing the weatherboards using nail guns, refer to the nail gun manufacturer for information about nails and the type of nail gun to be used
- D head nails - finish nails 2mm below the weatherboard surface
- RounDrive nails - finish nails flush with the weatherboard surface

For other fixing options Ask James Hardie™ on **0800 808 868**.

6.1.2 Fastener Durability

Fasteners must meet the minimum durability requirements of the NZBC. NZS 3604 specifies the requirements for fixing materials to be used in relation to exposure conditions and are summarised in Table 6.

Fasteners must be fully compatible with the other materials that they are to be in contact with, to ensure the durability of the complete assembly.

Also refer to the NZBC Acceptable Solution E2/AS1 Table 20 and 21 for information regarding the selection of suitable fixing materials and their compatibility with other materials.

Table 6

Exposure conditions and nail selection prescribed by NZS 3604		
Zone	Application	
D (sea spray) and geothermal hot spots	General	Stainless steel 304/316
	Fire	
*C and B	General	Hot dip galvanised**
	Fire	

*Zone C areas where local knowledge dictates that increased durability is required, appropriate selection shall be made. Microclimate conditions as detailed in NZS 3604, Paragraph 4.2.4 require SED.

**Hot dip galvanised must comply with AS/NZS 4680.

6.2 Framing

Oblique™ Weatherboard can be fixed either to a timber-frame or steel-frame.

For fixing to a steel frame Ask James Hardie™ on 0800 808 868 for specific requirements.

6.2.1 Frame Construction

Use of timber framing must be in accordance with NZS 3604 and the framing manufacturer’s specifications. The framing must be rigid and must not rely on the cladding for stability. Timber framing sizes and its set-out must comply with NZS 3604 and as specified in this technical specification.

The following framing is required:

- Studs must be provided at 600mm centres maximum
- Nogs must be provided as per framing requirements
- For EH and specific design projects exposed to wind pressures up to 3.2kPa, the stud spacing must be closed to 400mm centres maximum

In case of gable end trusses sitting on top plates of the external wall frame, the frame size must be in accordance with truss design and specification supplied by the frame and truss manufacturer/supplier supported by an independent design provider statement.

6.2.2 Special Framing Requirements

The following are special framing requirements for both timber and steel framing:

- Double studs are required at internal corners, refer to Figure 13
- Extra packers may be required at external corners

6.2.3 Tolerances

In order to achieve the required performance and an acceptable wall finish, it is imperative that framing is straight and true. Framing tolerances shall comply with Table 2.1 of NZS 3604 and the manufacturer’s specifications. All framing shall be made flush.

Also refer to MBIE guidance to tolerances , materials and workmanship etc. at www.building.govt.nz

6.3 Flexible underlay or HomeRAB™ Pre-Cladding

Flexible underlay/HomeRAB™ Pre-Cladding must be provided as per the requirements of External Moisture Clause E2 of the NZBC. The flexible underlay selected for use must comply with Table 23 of E2/AS1.

The flexible underlay must be fixed in accordance with section of 9.1.7 E2/AS1 and the underlay manufacturer's recommendations.

Walls which are not lined on the inside face (e.g. garage walls or gable ends) must include a rigid sheathing or an air barrier behind the cladding which complies with Table 23 of E2/AS1. For attached garages, flexible underlays must be selected in accordance with the NZBC Acceptable Solution E2/AS1, Paragraph 9.1.3.4. HomeRAB™ Pre-Cladding by James Hardie complies with these requirements and is suitable for use in this situation. It must be installed in accordance with the HomeRAB™ Pre-Cladding/RAB™ Board Installation Manual.

6.4 Intermediate Support for Flexible Underlays

Where studs are at 600mm centres an intermediate means of restraining the flexible underlay and insulation from bulging into the cavity shall be installed. An acceptable method to achieve this is using one of the following options:

- Intermediate cavity batten between the studs; or
- 75mm galvanised mesh; or
- Polypropylene tape at 300mm centres fixed horizontally and drawn taut

No intermediate supports are required:

- When studs are spaced at 400mm centres; or
- When rigid air barriers instead of flexible underlays are used

6.5 Rigid Air Barrier

In EH wind zone or for specific design wind zone, a rigid air barrier i.e. RAB™ Board, must be used instead of flexible underlay.

For buildings more than 10m, RAB™ Board must be used.

To achieve the temporary weathertightness using HomeRAB™ Pre-Cladding and RAB™ Board, windows/doors need to be installed with required flashing tapes and seals etc. Refer to HomeRAB™ Pre-Cladding and RAB™ Board Installation Manual for information regarding its installation and to achieve temporary weathertightness.

6.6 Flashings

All wall openings, penetrations, intersections, connections, window sills, heads and jambs must be flashed prior to Oblique™ Weatherboard installation. Refer to moisture management requirements in Clause 4.4. The flexible underlay/rigid air barrier must be appropriately incorporated with penetration and junction flashings using flashing tapes. Materials must be lapped in such a way that water tracks down to the exterior on the face of the flexible underlay or rigid air barrier board.

The selected flashing materials must comply with the durability requirements of the NZBC. For information refer to Table 20 of E2/AS1.

When using HomeRAB™ Pre-Cladding/RAB™ Board, the entire framing around openings must be protected with a flashing tape. The tape must be finished over the face of the rigid air barrier. Ensure to check the compatibility of flashing tapes and sealants with their manufacturer. Refer to the HomeRAB™ Pre-Cladding and RAB™ Board Installation Manual for further information.

6.7 Cavity Closure/Vent Strip

The Hardie™ 28mm Aluminium Cavity Closure or uPVC cavity vent strip must be installed at the bottom of all walls and above all openings constructed using the drained and ventilated cavity construction method. It is important that the openings in the cavity closure/vent strip are kept clear and unobstructed to allow free drainage and ventilation of cavities. Hardie™ cavity closure/vent strip has an opening area of 1000mm²/m length.

6.8 Cavity Battens

Oblique™ Weatherboard must be installed on a cavity. The battens provide ventilation and drainage between the frame and the weatherboard and are considered a “packer” only in this specification.

The timber cavity battens must be minimum H3.1 treated in accordance with NZS 3640 (Chemical preservation of rough and sawn timber) to comply with the durability requirements of B2/AS1.

Cavity battens must comply with E2/AS1 and:

- Be minimum 18mm thick
- Be as wide as the width of studs
- Fixed vertically to studs
- Must be fixed by the cladding fixings to the main framing over the flexible underlay. Therefore until claddings are fixed the battens only need to be tacked to framing by 40 x 2.8mm or longer nails at 800mm centres

6.9 Joints

6.9.1 Vertical Joint

Oblique™ Weatherboard shall be jointed using the trimline joint flashing. Refer to Figures 8 to 10.

A single stud is required when using the trimline joint flashing. Refer to Figure 8.

Alternatively if a vertical joint flashing shall be used a double stud is required for this joint, refer to Figure 10.

6.9.3 Horizontal Joint

Oblique™ Weatherboards are lapped over each other as per Figures 3 and 4. There is a 23-25mm lap between the two weatherboards. Ensure that the Oblique™ Weatherboards are securely interlocked before nailing. Oblique™ Weatherboard can run continuous over floor joists without any horizontal joint when LVL timber floor joists or an engineered joist are used, refer to Figure 31.

When using a solid timber joist, a horizontal joint or a movement joint must be formed at floor joist, refer to Figures 30 and 32.

6.9.4 Drainage Joint

After every two floors a horizontal drainage joint flashing is required, refer to Figure 32.

For buildings higher than 3 storey, from a vertical fire spread safety perspective, a horizontal drainage joint is required at each floor.

6.9.5 External Corner

An external box corner flashing is used to fix the external corners, refer to Figure 11. Alternatively an Hardie™ Axent™ Trim external boxed corner can also be formed, refer to Figure 12.

6.9.6 Internal Corner

An internal corner flashing is to be used to form an internal corner joint, refer to Figure 13.

An extra stud is required in internal corners.

Note: All vertically installed mouldings to be fixed at 400mm centres both sides.

6.10 Junctions and Penetrations

Refer to Clause 2.5 of this specification for moisture management requirements. All windows and doors must be detailed as per the requirements of this specification. For an example of window details for Oblique™ Weatherboard which meet the performance requirements of E2 External Moisture, an approved document of the NZBC, refer to Figures 18 to 29.

7 Finishes

7.1 Preparation

The D head nail must be finished 2mm below the weatherboard surface. The nail holes must be filled with an exterior grade two part builders fill, ie. CRC® ADOS® Builders Fill or similar two part external grade filler. The RoundDrive nail heads must finish flush with weatherboard surface.

7.2 Painting

Oblique™ Weatherboard is pre-primed and is suitable for site applied acrylic paints.

In order to seal cut edges or sanded patches, Dulux® 1 Step, Acraprime® 501/1, Resene® Quick Dry, Taubmans® Underproof Acrylic Primer undercoat or a similar product should be applied. The primer should be compatible with the paint to be used.

Painting of Oblique™ Weatherboard is mandatory to meet the durability requirements of the NZBC and 25 year James Hardie product warranty. Oblique™ Weatherboard must be dry and free of any dust or grime before painting. The weatherboards must be painted within 90 days of their installation. There is no restriction on the LRV of paint to be applied on the Oblique™ Weatherboard. All exposed faces, including the top edges under the sills and bottom edges of Oblique™ Weatherboard and accessories must be finished with an exterior paint system.

James Hardie recommends a minimum of two coats of exterior grade acrylic paint. Follow the paint manufacturer's recommendations to prepare the surface and to adequately cover and conceal the weatherboard fixings.

For best aesthetic results a low sheen paint is recommended.

7.3 Flexible Sealant

Sealant used must comply with the relevant requirements of the NZBC. Their application and usage must be in accordance with the manufacturer's instructions. Check with the sealant manufacturer prior to coating over sealant. Some sealant manufacturers do not recommend coating over their product.

8 Care and Maintenance

The extent and nature of maintenance required will depend on the geographical location and exposure of the building. It is the responsibility of the specifier to determine normal maintenance requirements to maintain the effectiveness of the cladding.

As a guide, it is recommended that the basic normal maintenance tasks shall include, but not be limited to:

- Washing down exterior surfaces every 6 - 12 months using low pressure water and a brush, and every 3-4 months in extreme coastal conditions or sea spray zones. Do not use a water blaster to wash down the cladding. Refer to your paint manufacturer for washing down requirements.
- Re-coating exterior protective finishes. Always refer to your paint manufacturer for re-coating requirements.
- Regular inspection and repair if necessary of the cladding, joints, sealants, nail head fillers
- Cleaning out gutters, down pipes and overflow pipes as required
- Pruning back vegetation which is close to or touching the Oblique™ Weatherboard as well as ensuring the NZBC ground clearance requirements are maintained, especially where gardens are concerned
- The clearance between the bottom edge of the Oblique™ Weatherboard and the finished/unfinished ground must always be maintained

9 Details

The following generic details have been provided in this document for cavity construction methods.

Table 7

Description	Cavity Construction
Figure 1: Typical storey Layout	23
Figure 2: Batten set out	24
Figure 3: Fixing detail	25
Figure 4: 300mm fixing in EH or SED wind zone and fire rated walls	26
Figure 5: Foundation detail – option 1	27
Figure 6: Foundation detail – option 2	28
Figure 7: Enclosed deck	29
Figure 8: Vertical jointing option 1	30
Figure 9: Vertical trimline joint flashing	31
Figure 10: Vertical jointing option 2	32
Figure 11: External aluminium box corner	33
Figure 12: Trim external box corner	34
Figure 13: Internal aluminium corner	35
Figure 14: Soffit detail	36
Figure 15: Nil soffit	37
Figure 16: Soffit top ventilation	38
Figure 17: Nil soffit top ventilation	39
Figure 18: Window sill	40
Figure 19: Window jamb	41
Figure 20: Window jamb with scriber	42
Figure 21: Window head with full cladding across flashing	43
Figure 22: Window head with cladding cut around head flashing	44
Figure 23: Window head stop end	45
Figure 24: Window jamb flashing	46
Figure 25: Window sill with facing	47
Figure 26: Window jamb with facing	48
Figure 27: Window head with facing	49
Figure 28: Door sill support detail	50
Figure 29: Pipe penetration	51
Figure 30: Trimline joint flashing at floor level	52
Figure 31: Continuous cladding over joist at floor level	53
Figure 32: Drained flashing joint at floor level	54
Figure 33: Trimline joint flashing at external corner	55
Figure 34: Trimline joint flashing at full external corner	56
Figure 35: Trimline joint	57
Figure 36: Trimline joint flashing at internal corner	58
Figure 37: Drained flashing joint at external corner	59
Figure 38: Parapet flashing	60
Figure 39: Apron Flashing detail	61
Figure 40: Roof to wall junction detail	62
Figure 41: Garage head	63
Figure 42: Garage jamb	63
Figure 43: Cavity batten layout for heights over 10m	64
Figure 44: Cavity fire barrier for heights over 10m	65

Figure 1: Typical storey Layout

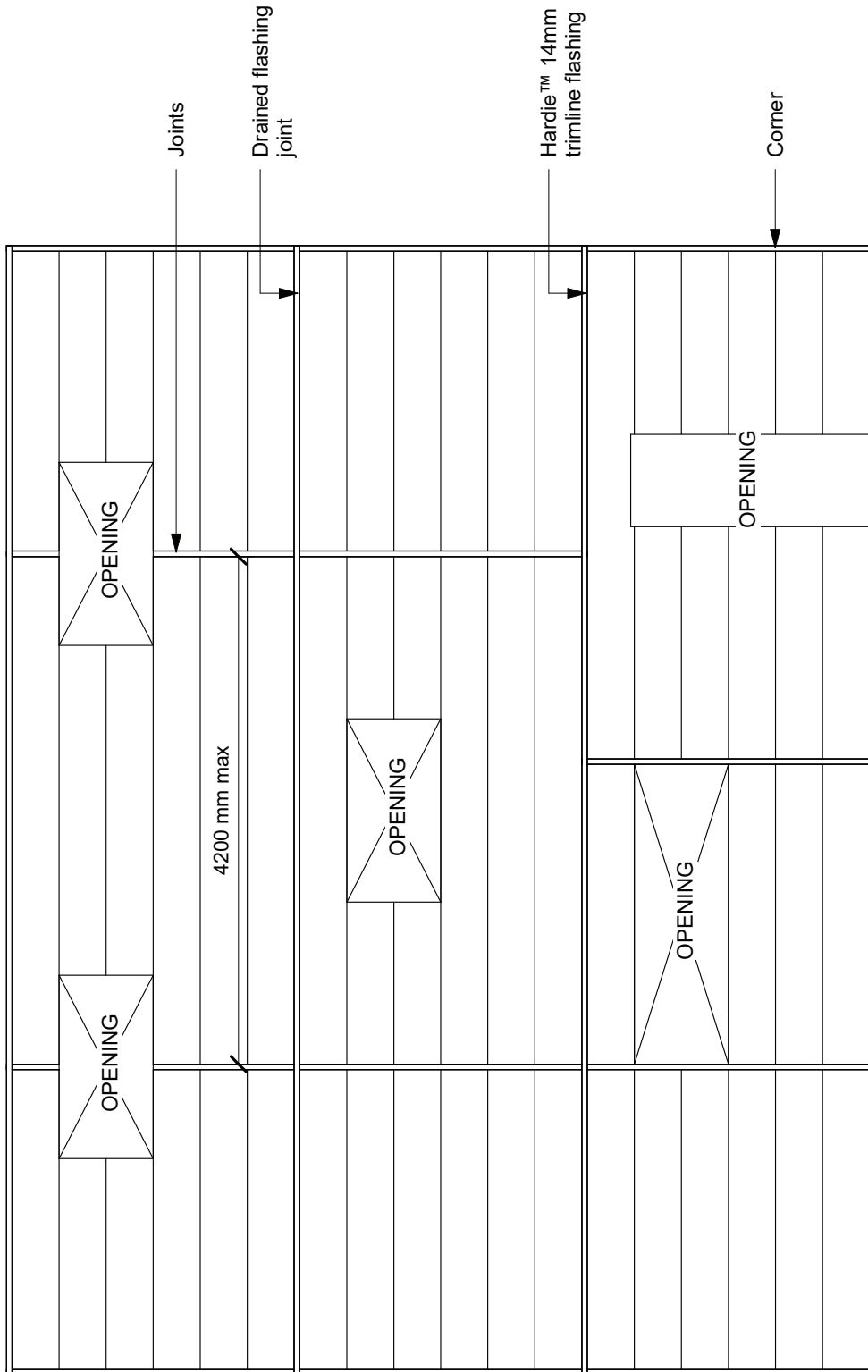
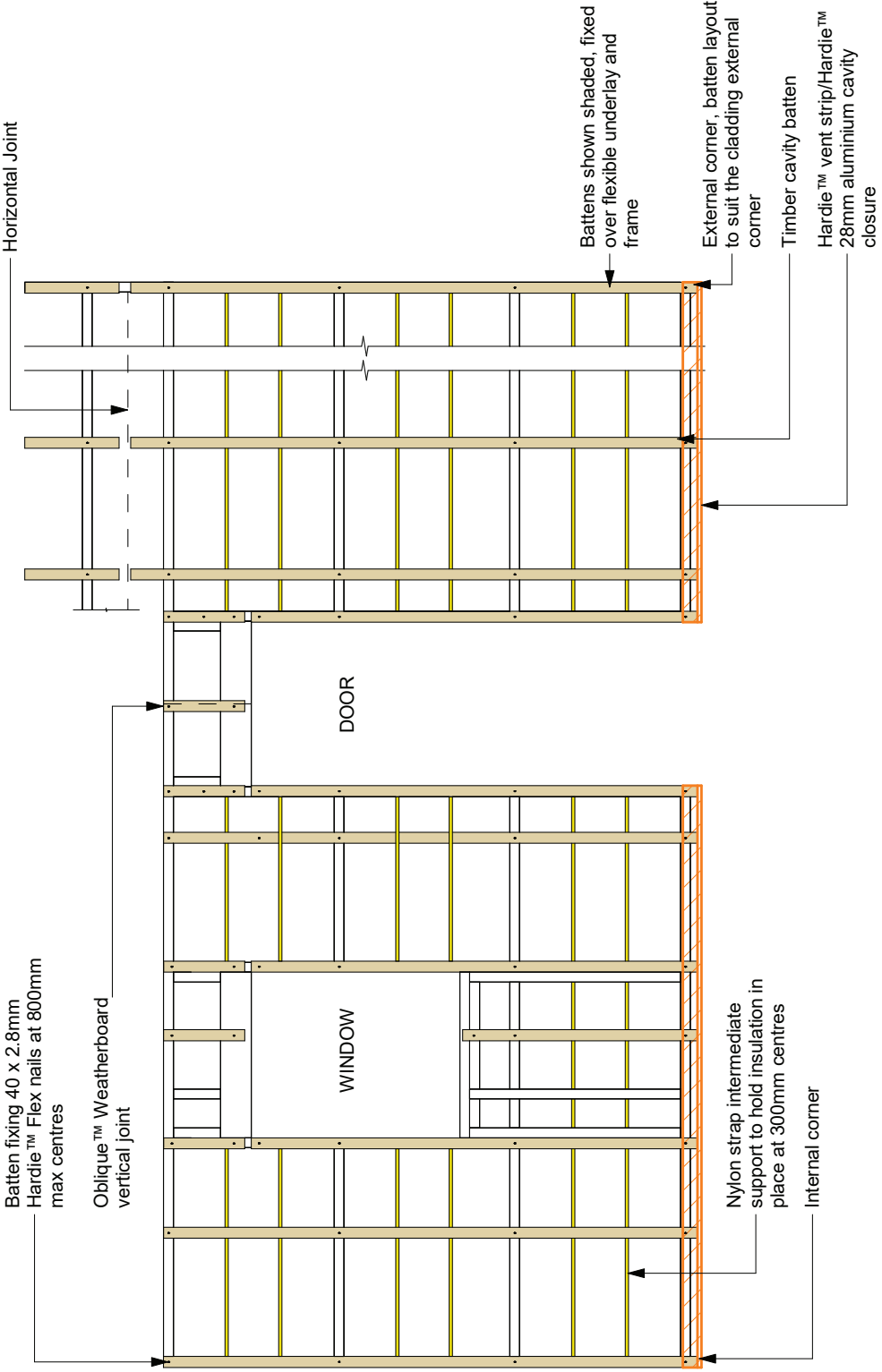

Figure 2: Batten set out



Note:

- Maximum stud spacing 600mm centres
- If studs are placed at 400mm centres no intermediate support is required

Figure 3: Fixing detail

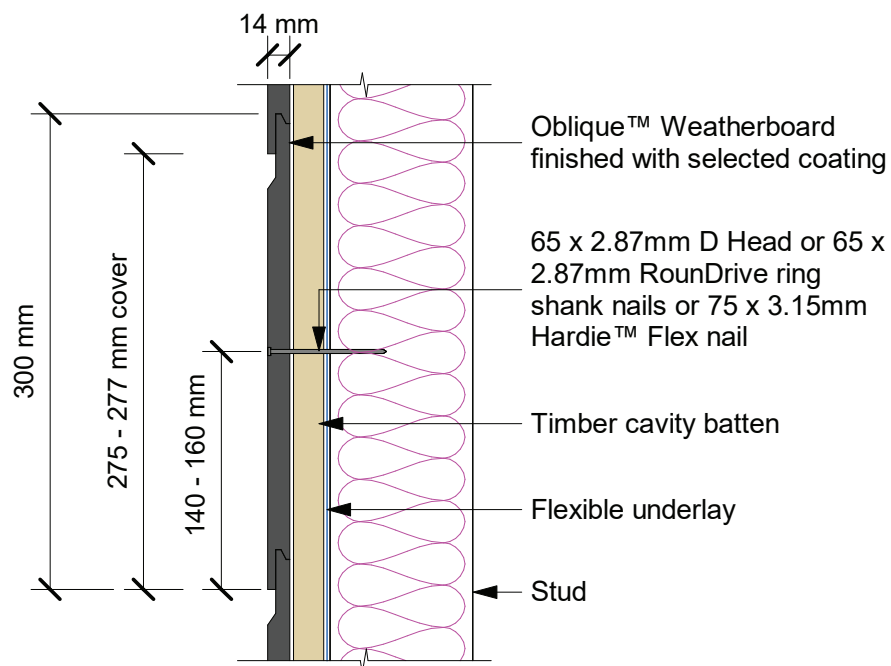
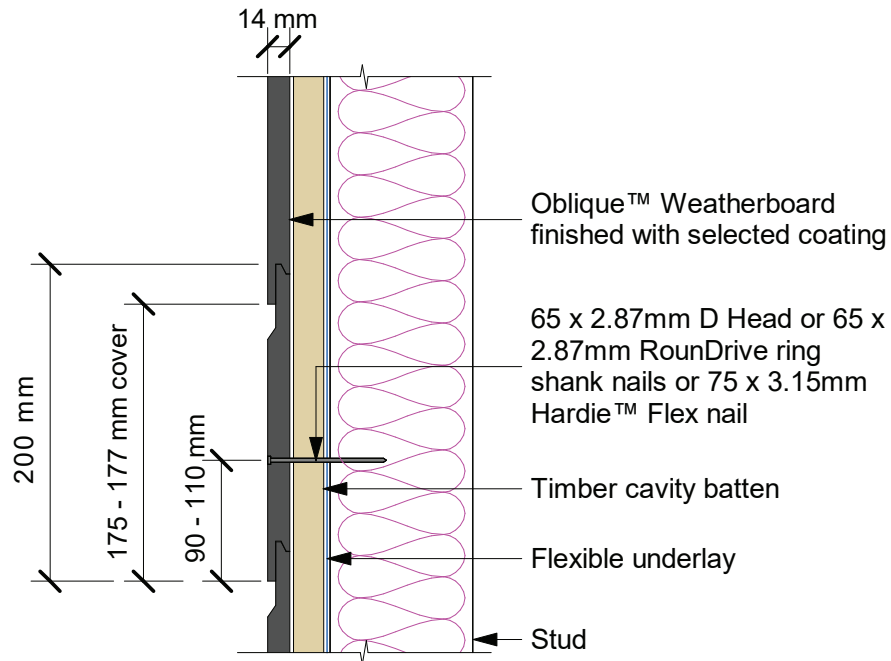

Figure 4: 300mm fixing in EH or SED wind zone and fire rated walls

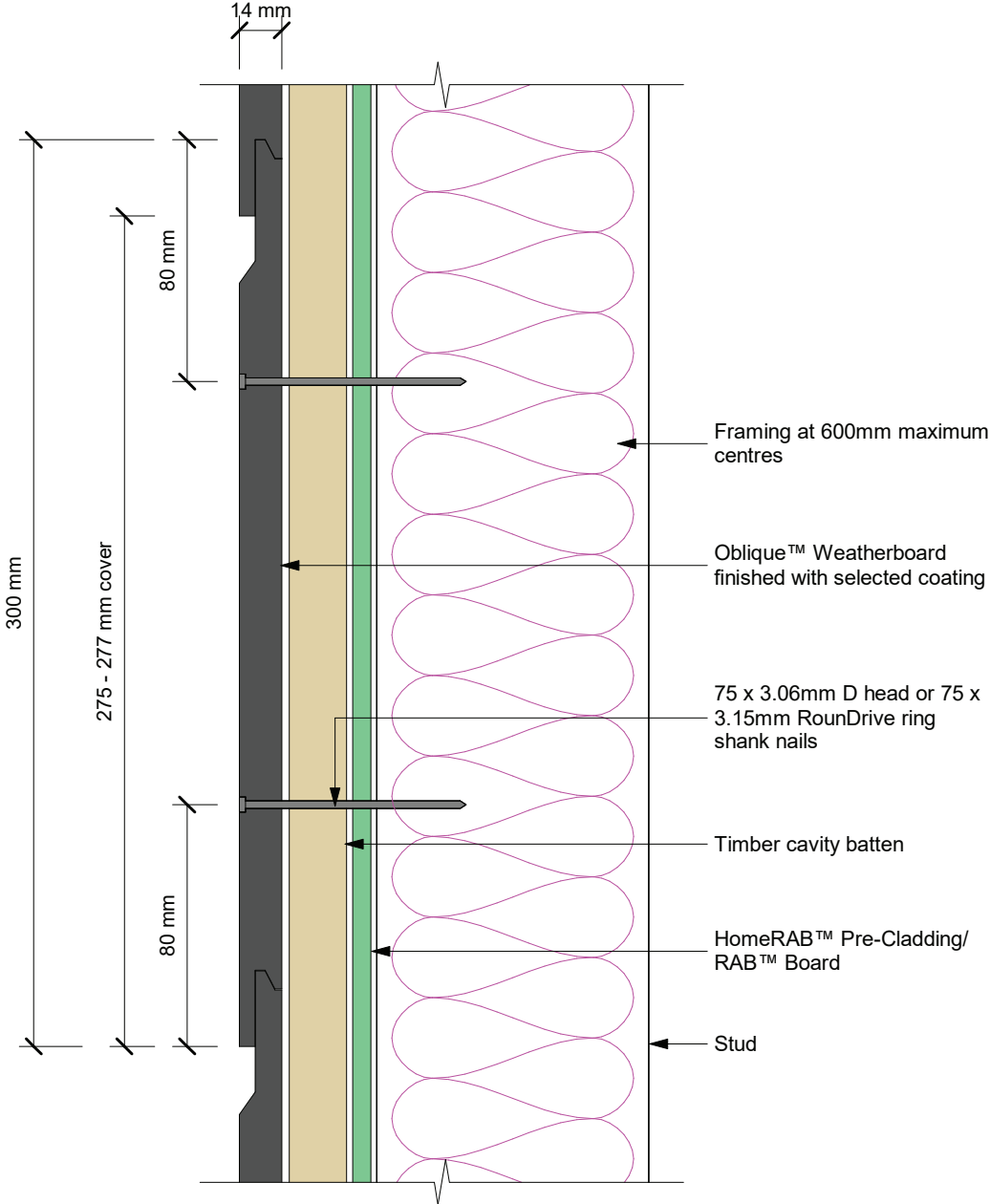
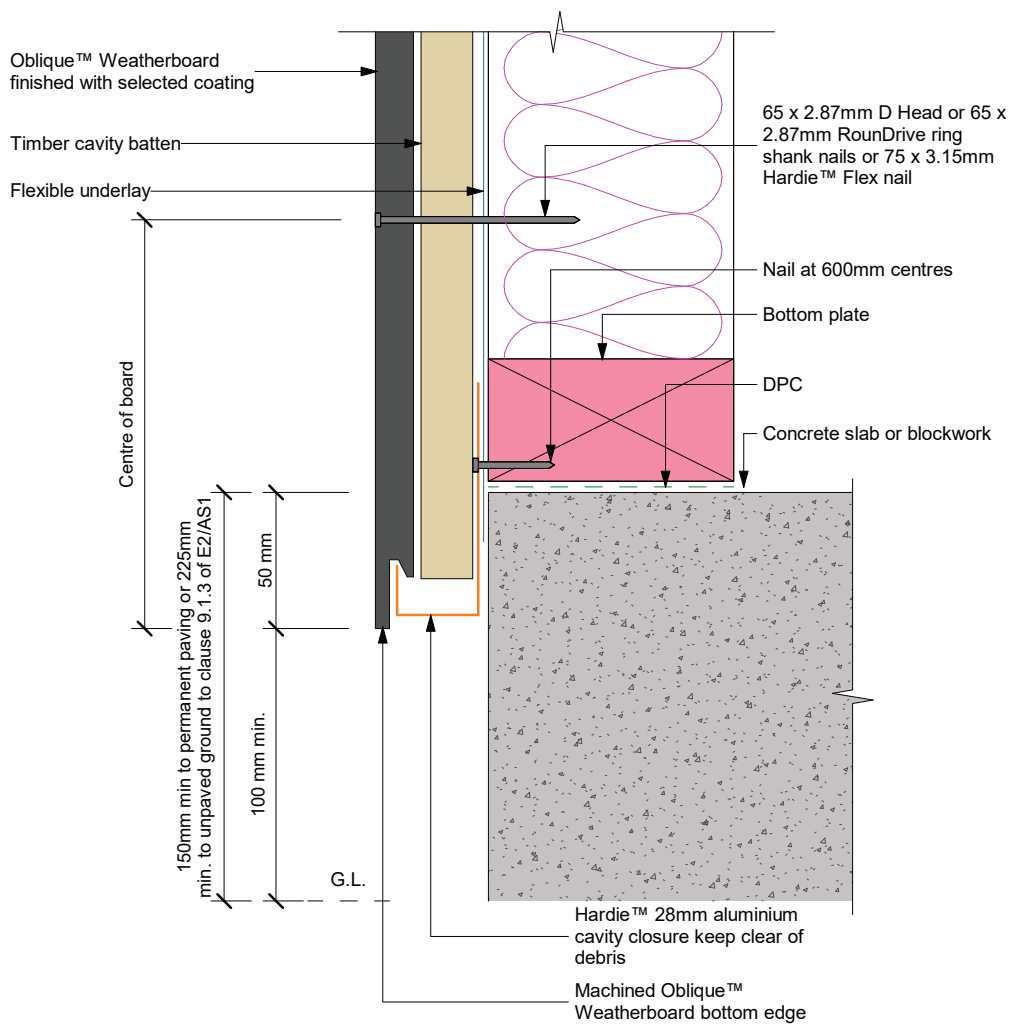
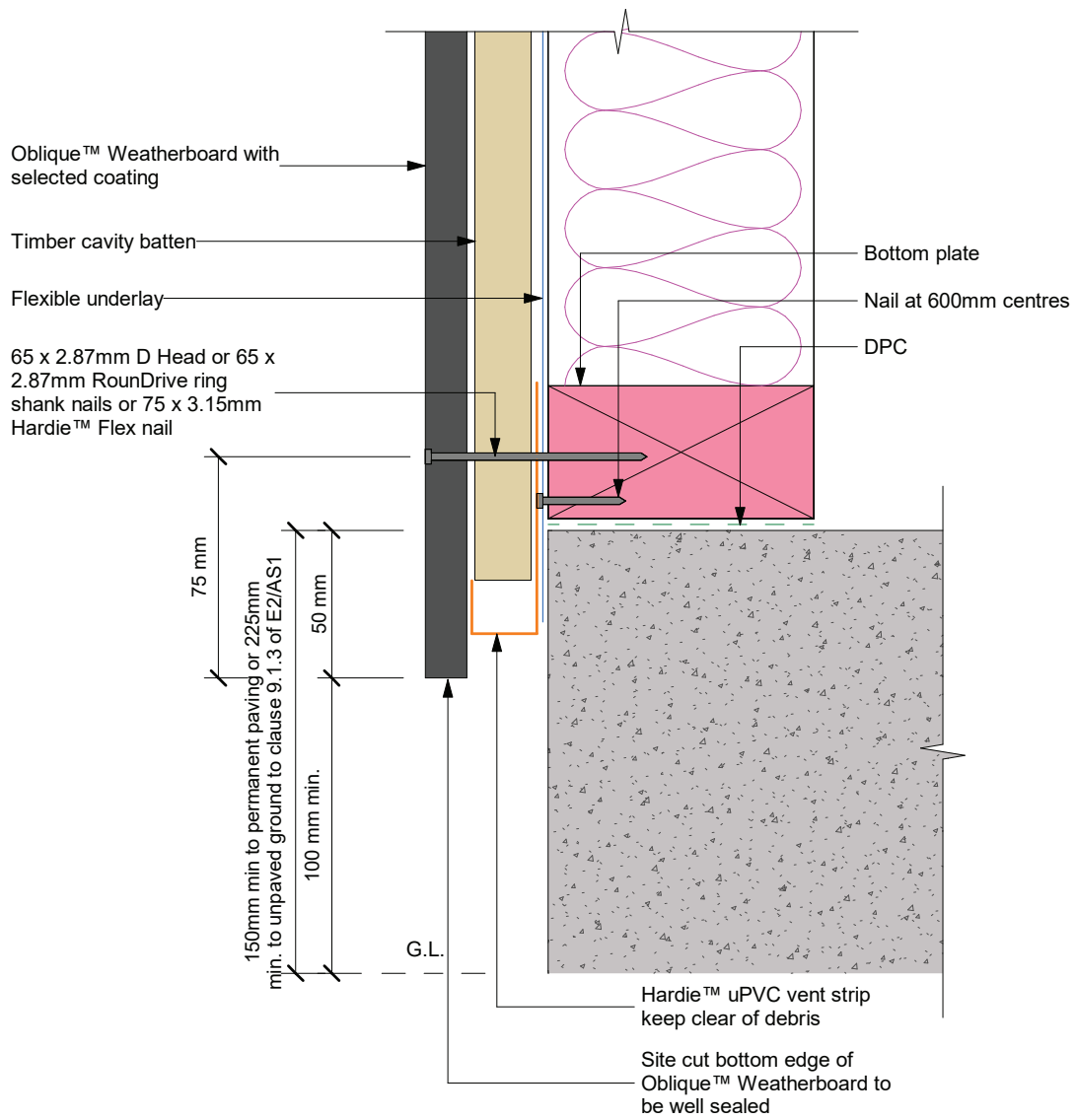

Figure 5: Foundation detail – option 1



Note: Site cut edges to be primed

Figure 6: Foundation detail – option 2



NOTE: Site cut edges to be primed

Figure 7: Enclosed deck

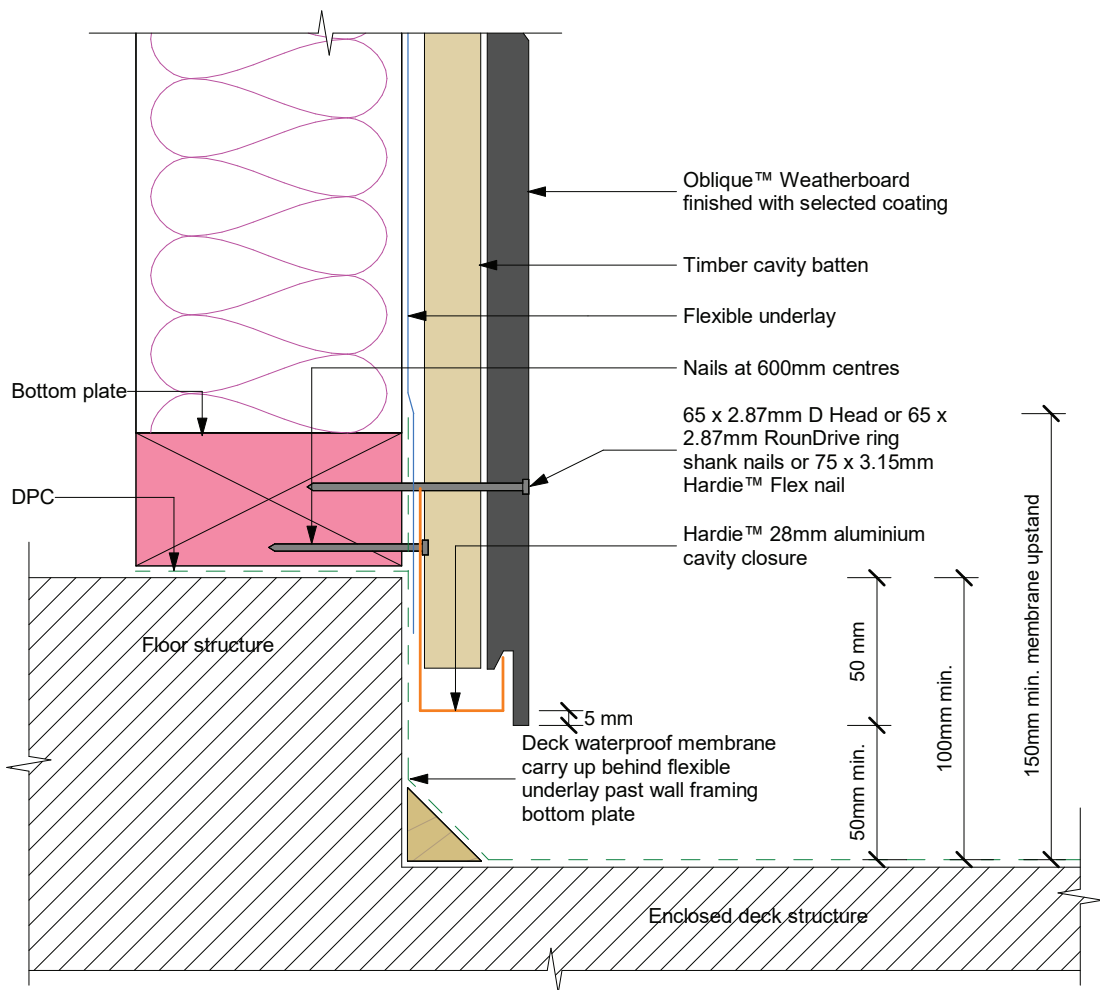

Figure 8: Vertical jointing option 1

65 x 2.87mm D Head or 65 x 2.87mm RoundDrive ring shank nails or 75 x 3.15mm Hardie™ Flex nail

Timber cavity batten

Flexible underlay

Hardie™ 14mm trimline joint flashing

Apply 4mm continuous bead of flexible sealant to end of Oblique™ Weatherboard prior to butting to trimline joint

Oblique™ Weatherboard with selected coating

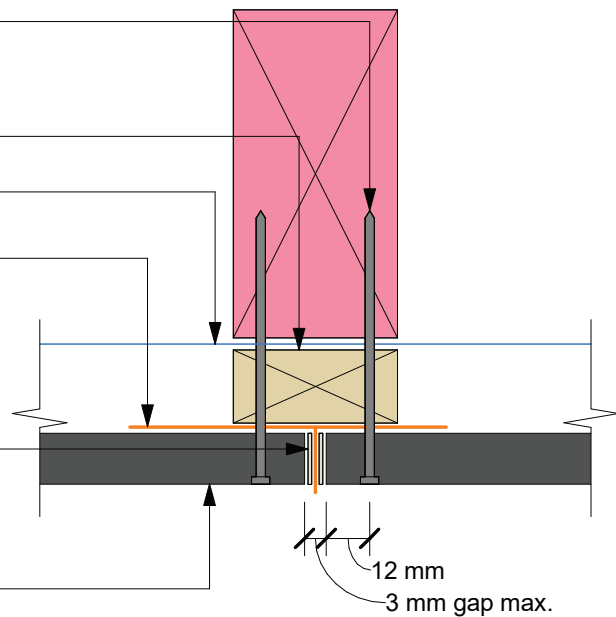

Note: Site cut edges to be primed

Figure 9: Vertical trimline joint flashing

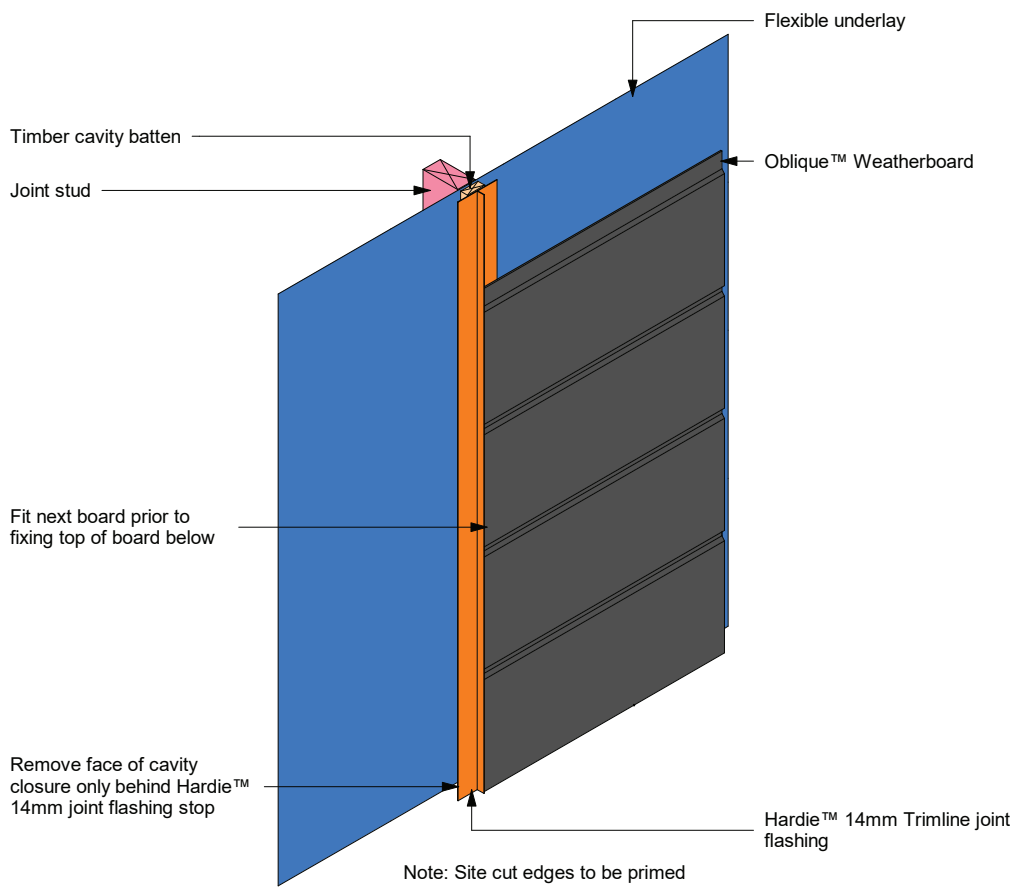
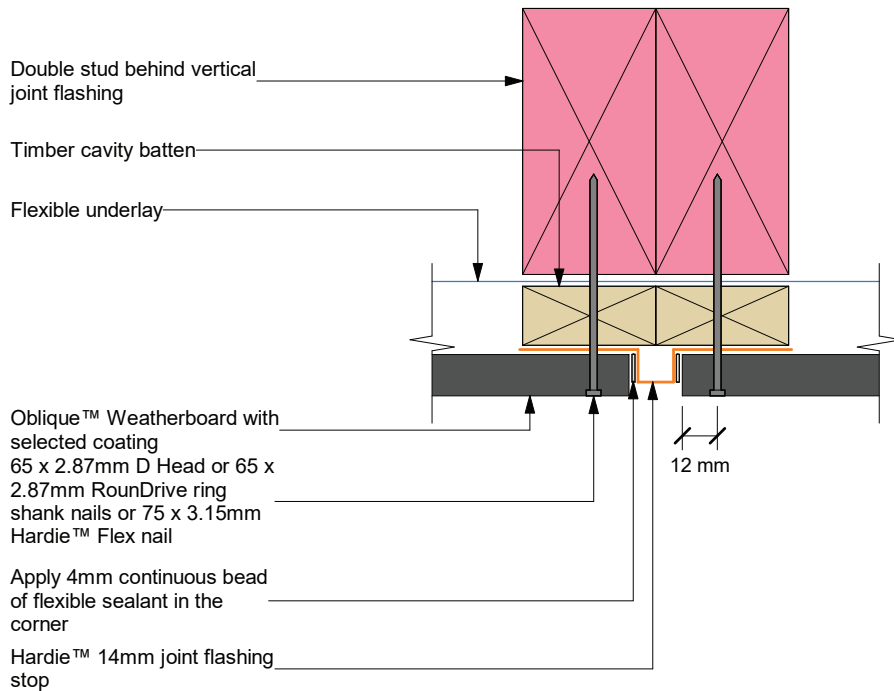

Figure 10: Vertical jointing option 2



Note: Site cut edges to be primed

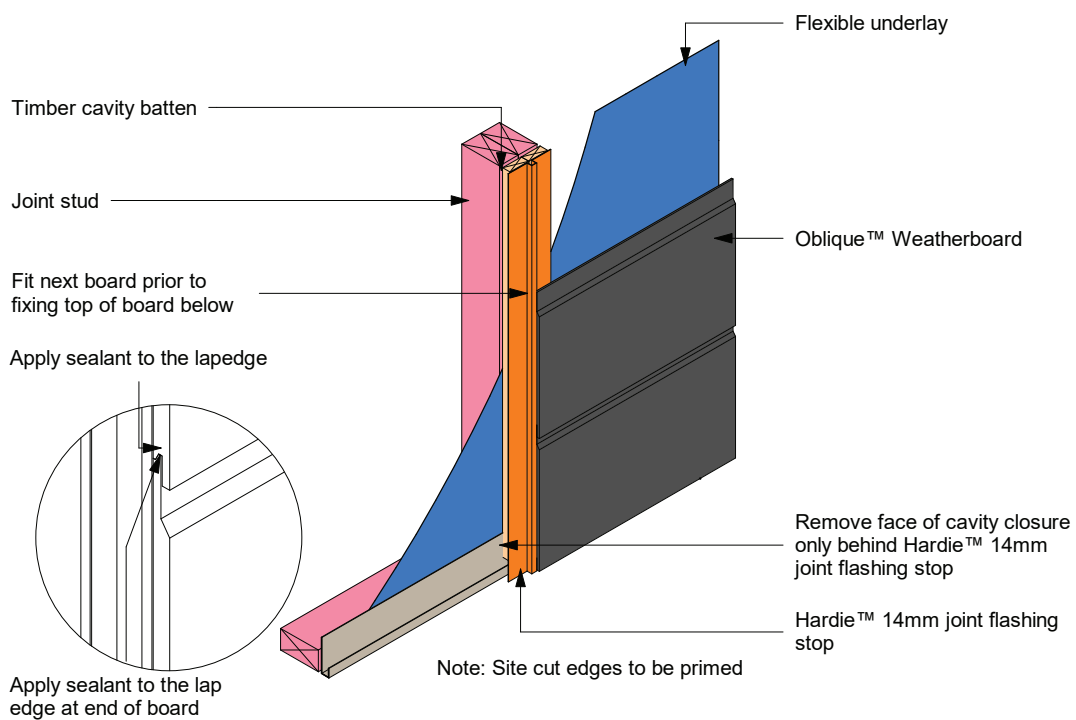
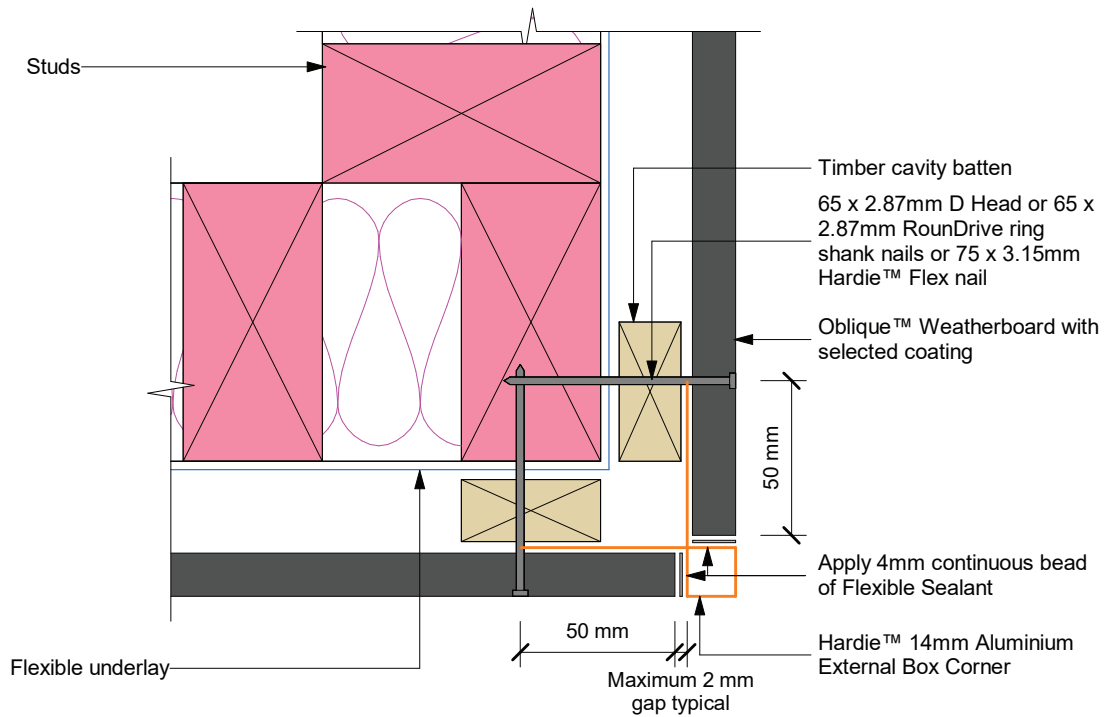

Figure 11: External aluminium box corner



Note: Site cut edges to be primed

Figure 12: Trim external box corner

interactive assembly instructions available
<http://wksp.nz/jh-lo-hexat>



Get WORKINGSPEC from Apple App Store/Google Play

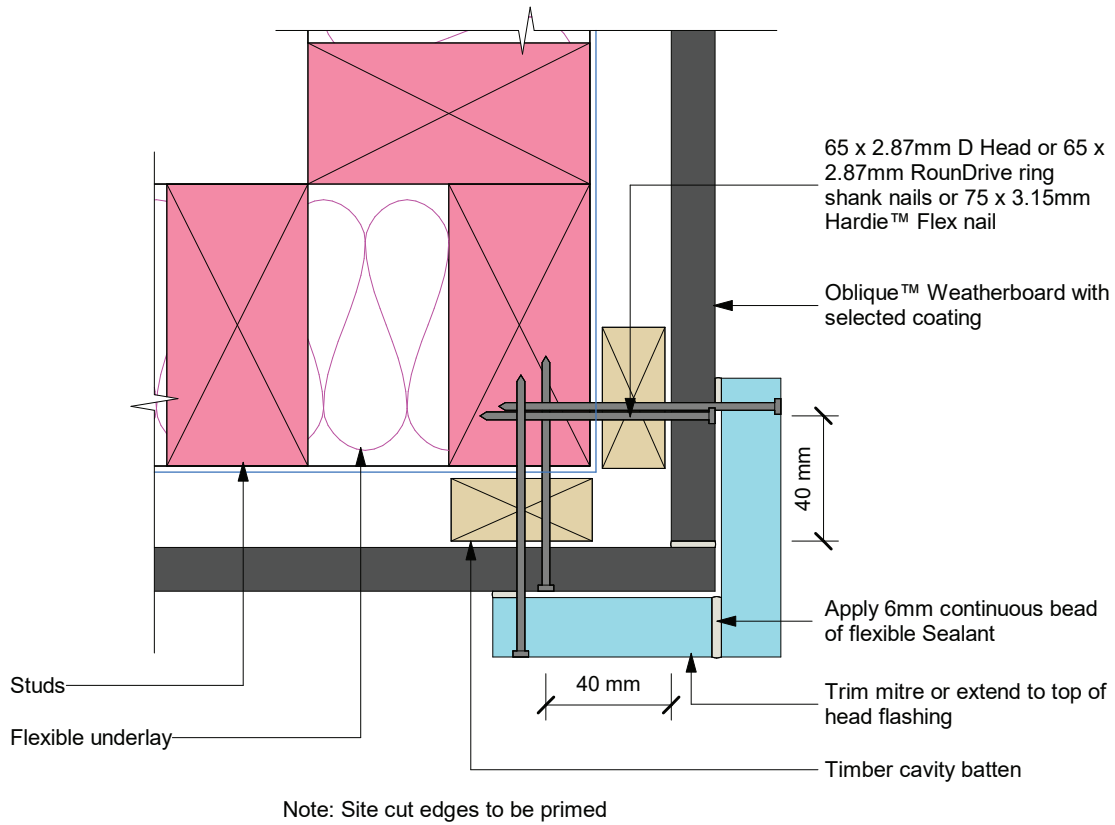
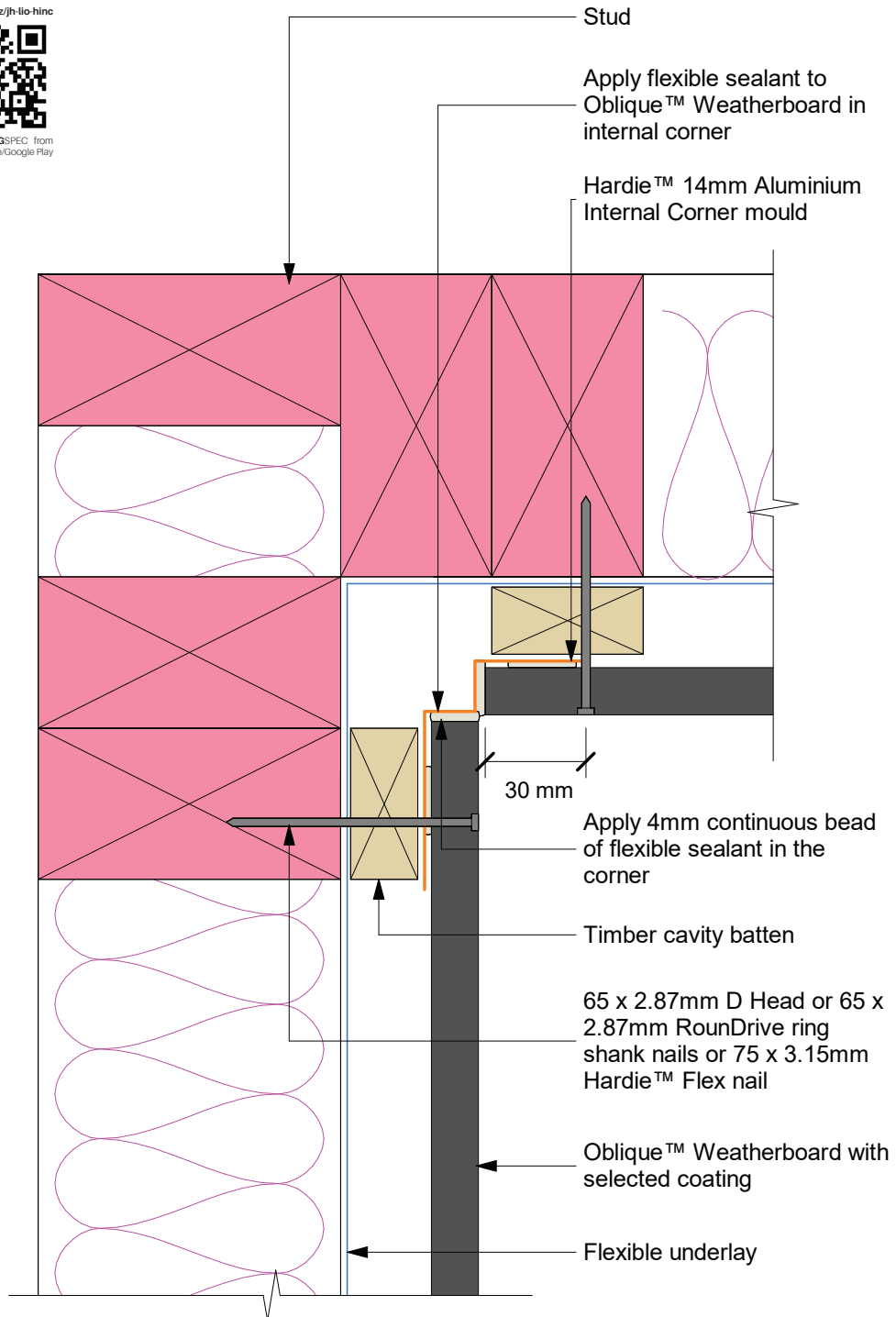
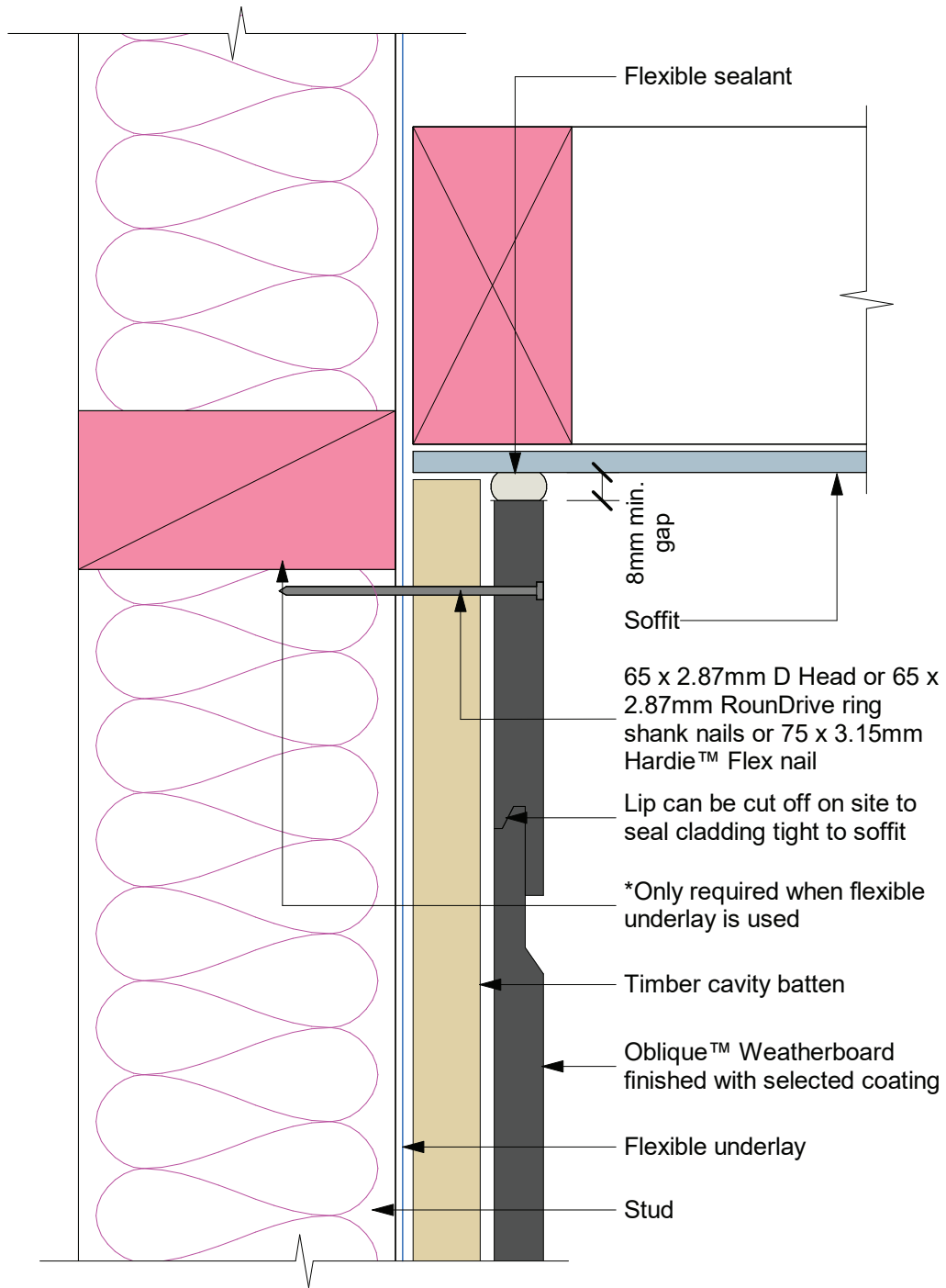

Figure 13: Internal aluminium corner



Note: Site cut edges to be primed

Figure 14: Soffit detail



Note: Site cut edges to be primed

Figure 15: Nil soffit

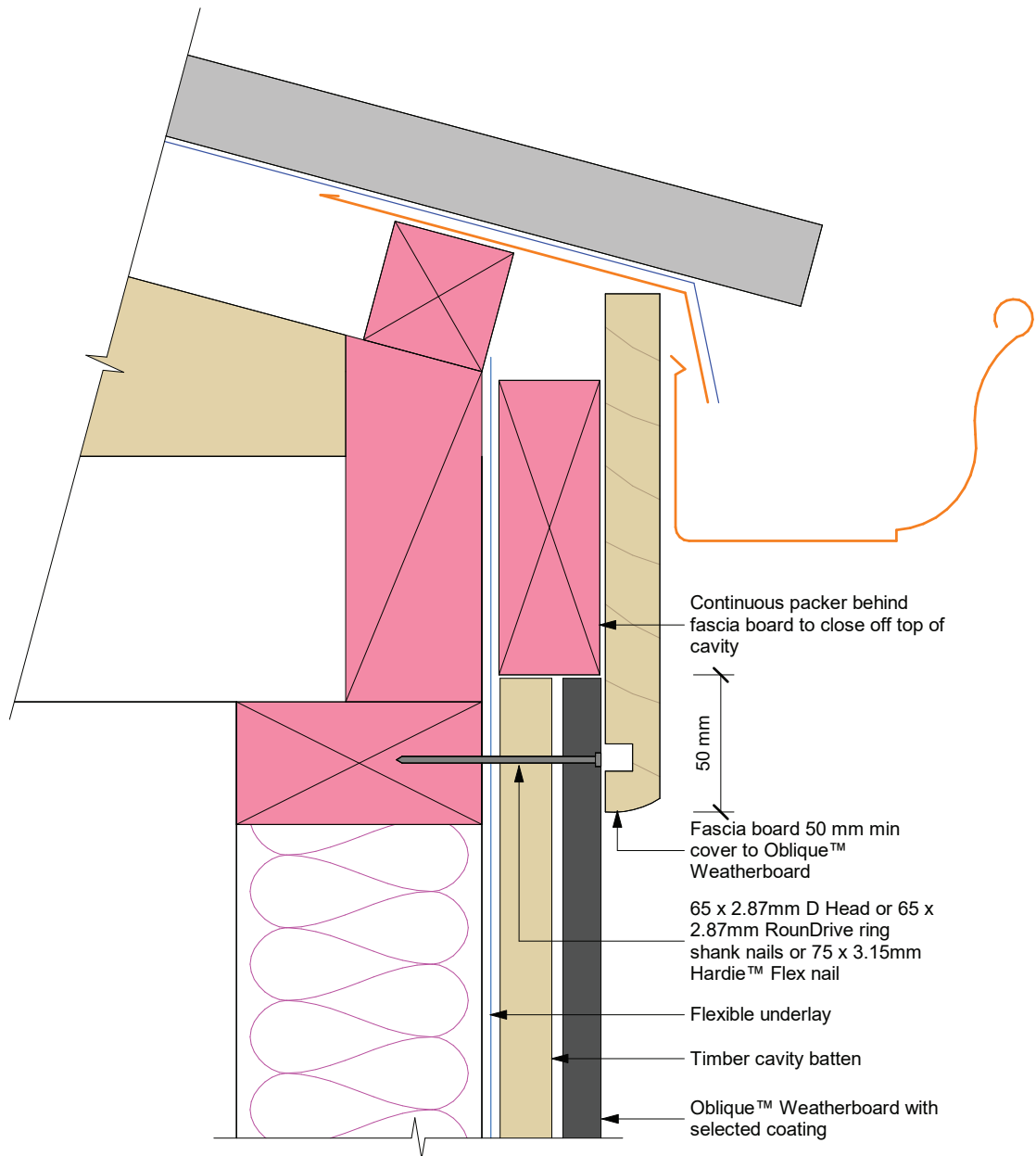

Figure 16: Soffit top ventilation

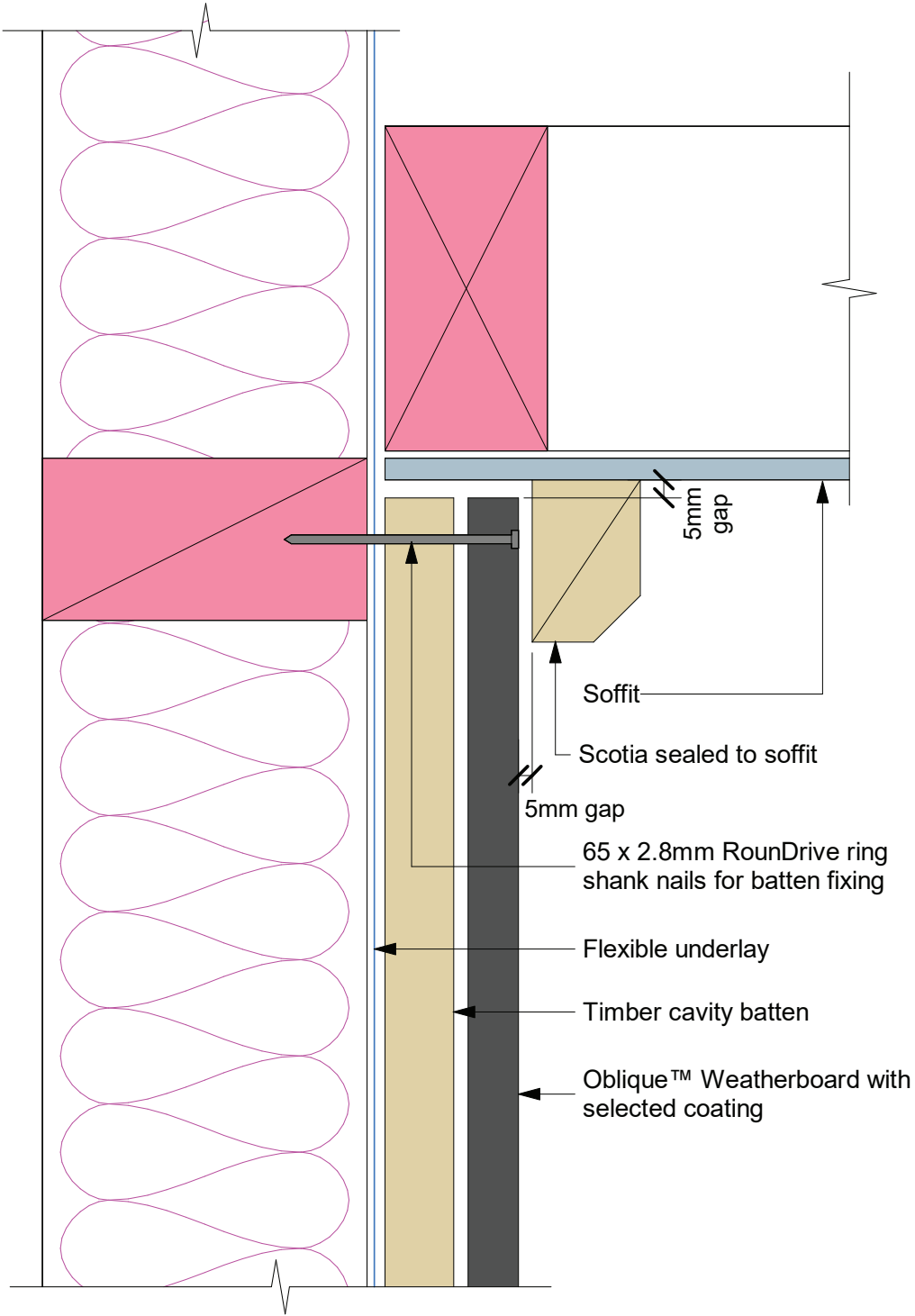

Figure 17: Nil soffit top ventilation

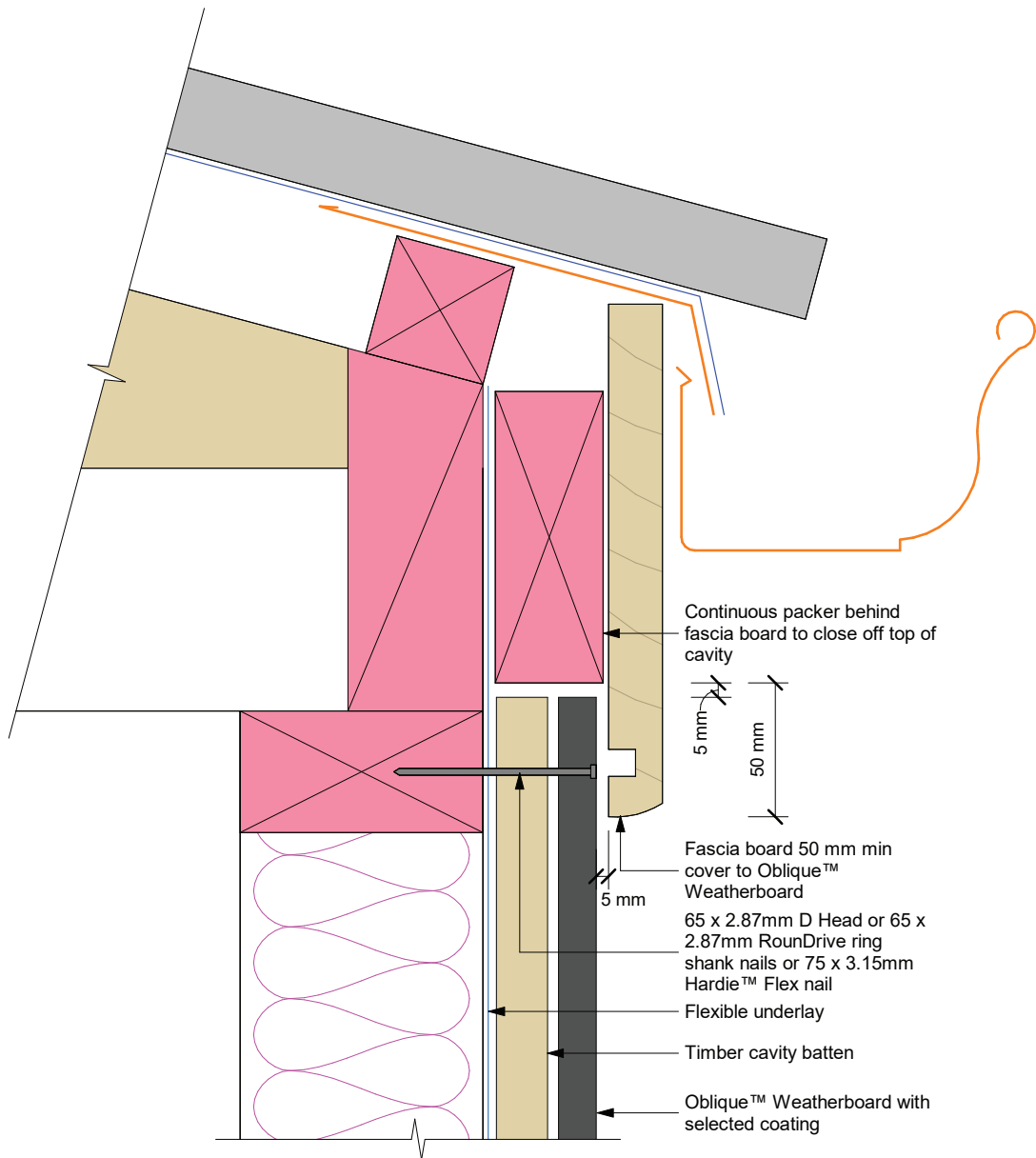

Figure 18: Window sill

interactive assembly
instructions available

<http://wksp.nz/jh-lto-hwin>



Get WORKINGSPEC from
Apple App Store/Google Play

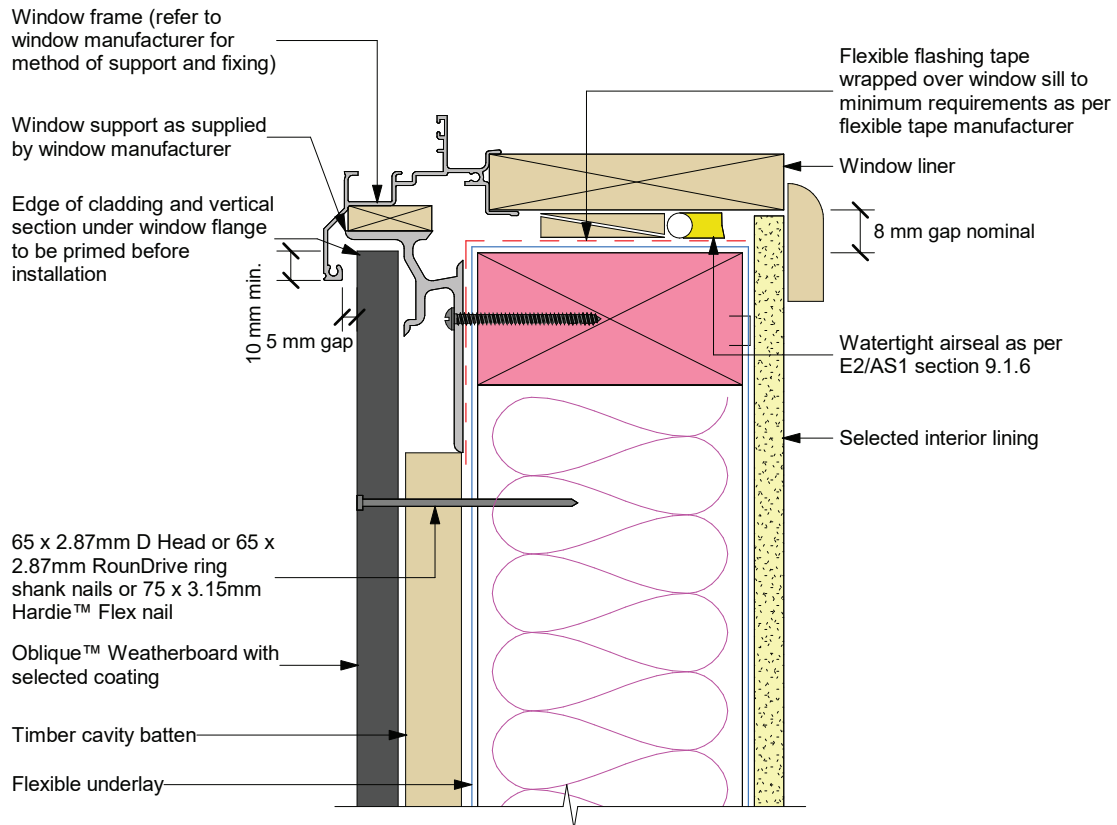

General notes for materials selection

1. Flashing materials must be selected based on environmental exposure, refer to NZS 3604 and Table 20 of the NZBC E2/AS1
2. Flexible underlay must comply with acceptable solution E2/AS1
3. Flashing tape must have proven compatibility with the selected flexible underlay and other materials with which it comes into contact

Refer to the manufacturer or supplier for technical information for these materials

Figure 19: Window jamb

Interactive assembly instructions available
<http://wksp.nz/jh-lto-hwin>



Get WORKINGSPEC from Apple App Store/Google Play

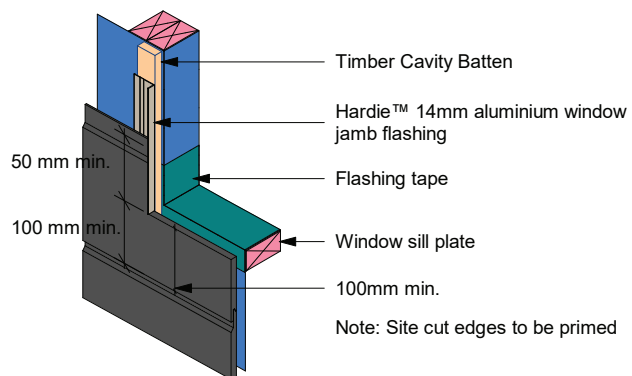
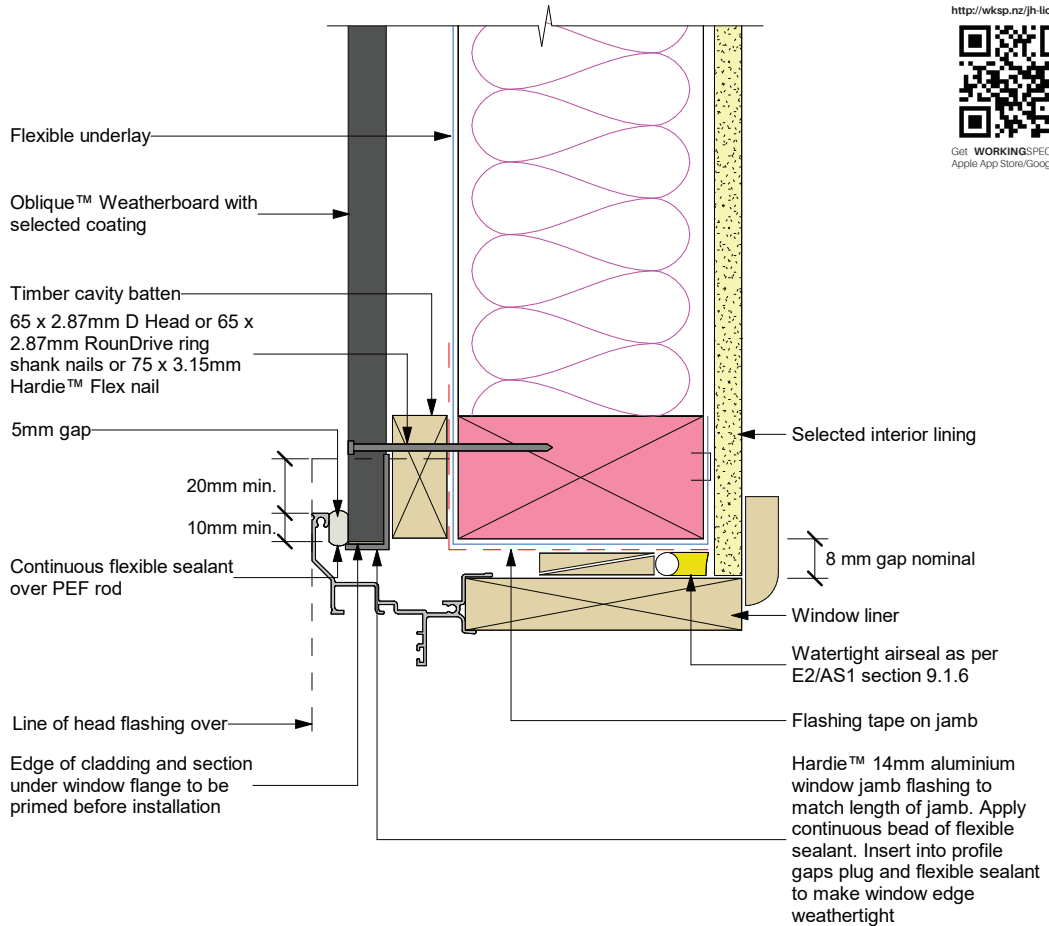

- Note:
1. Site cut edges to be primed
 2. Window frame omitted for clarity

Figure 20: Window jamb with scribe

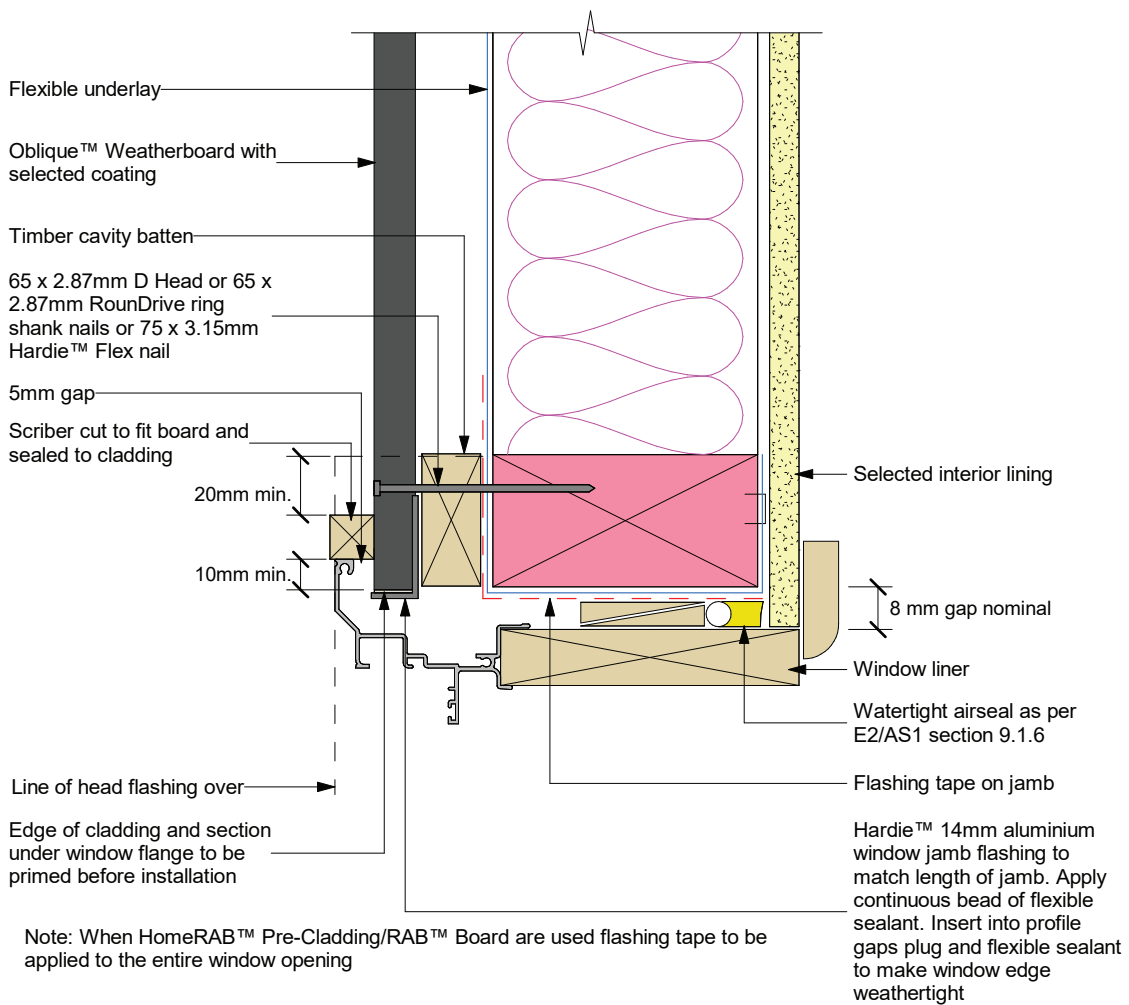
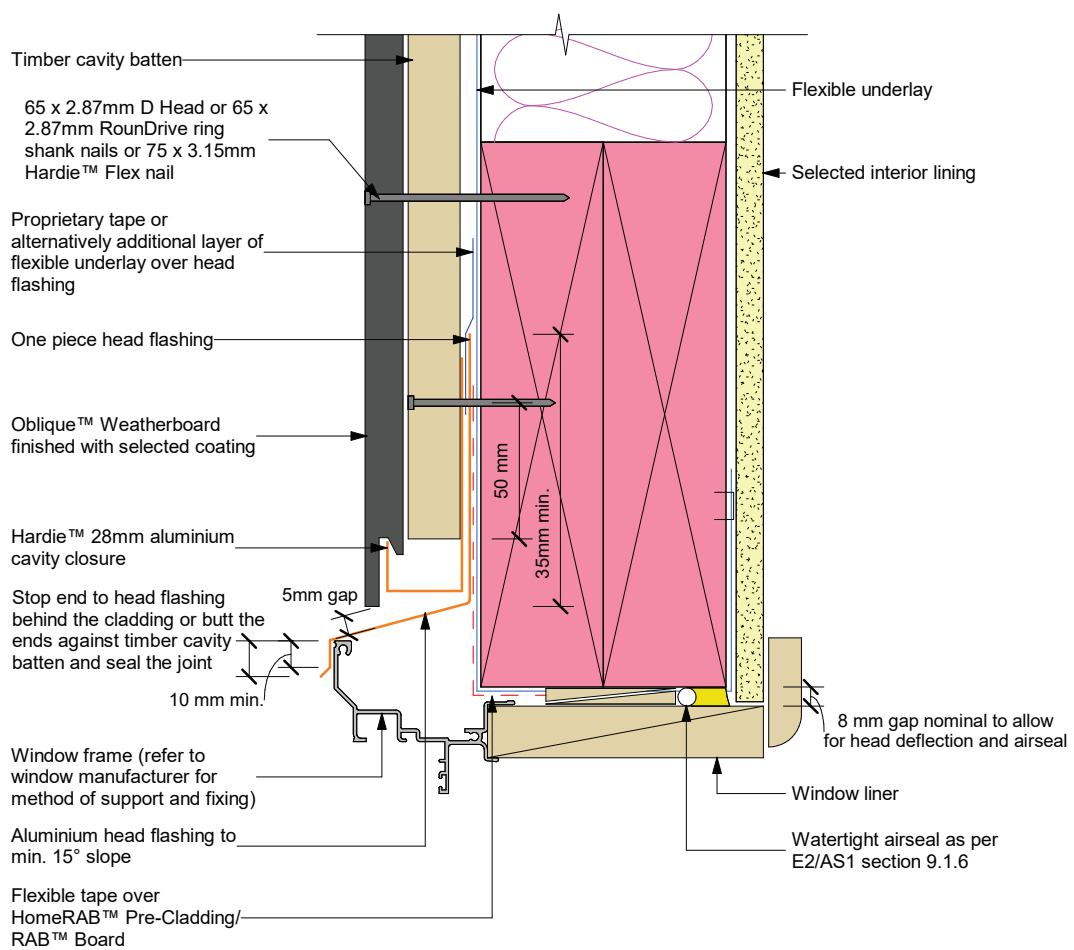
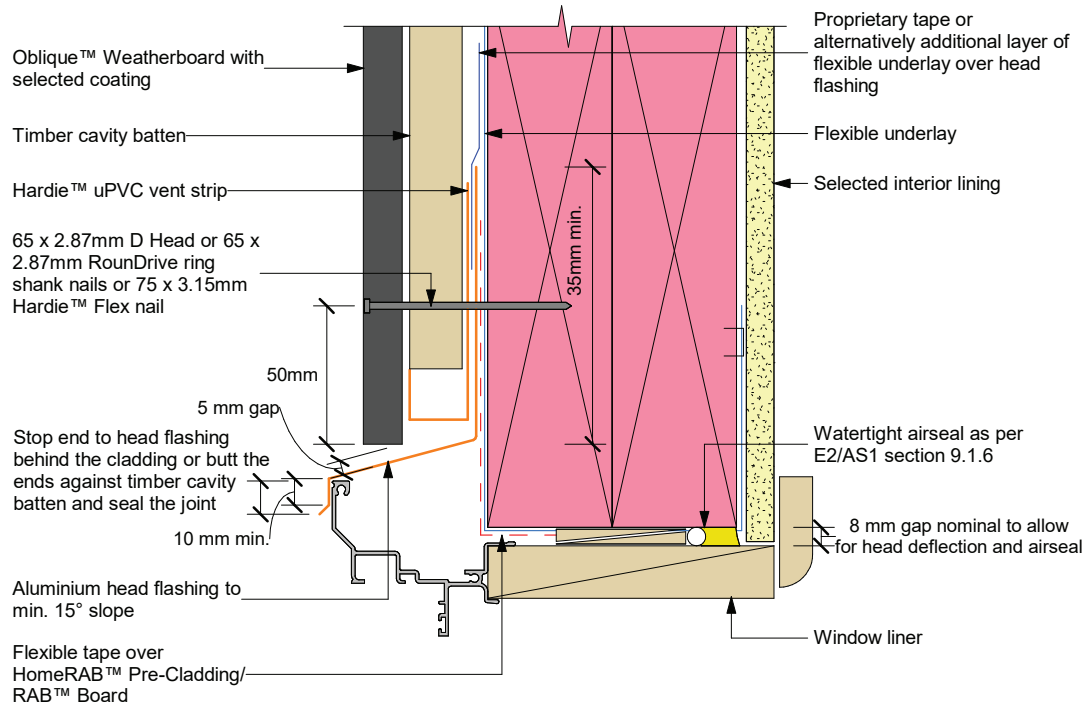

Figure 21: Window head with full cladding across flashing



- Note:**
- Site cut edges to be primed
 - Sealant must be installed between head flashing and window flange in VH and above wind zones. Refer to Figure 71 of E2/AS1

Figure 22: Window head with cladding cut around head flashing



- Note:
- Site cut edges to be primed
 - Sealant must be installed between head flashing and window flange in VH and above wind zones. Refer to Figure 71 of E2/AS1

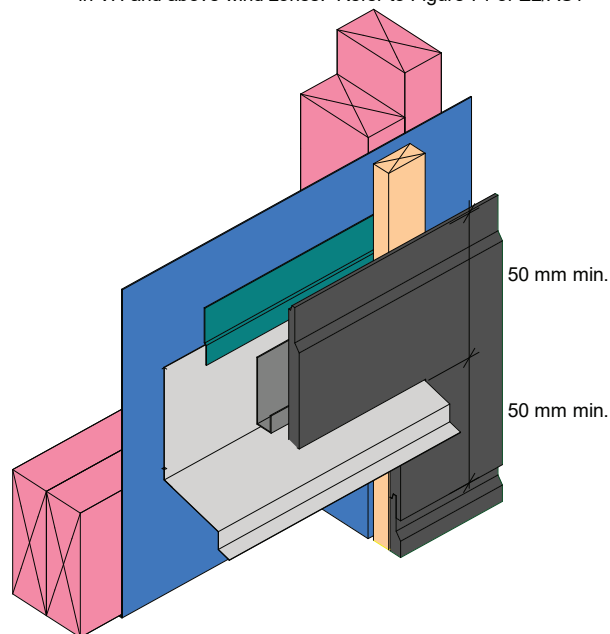

Figure 23: Window head stop end

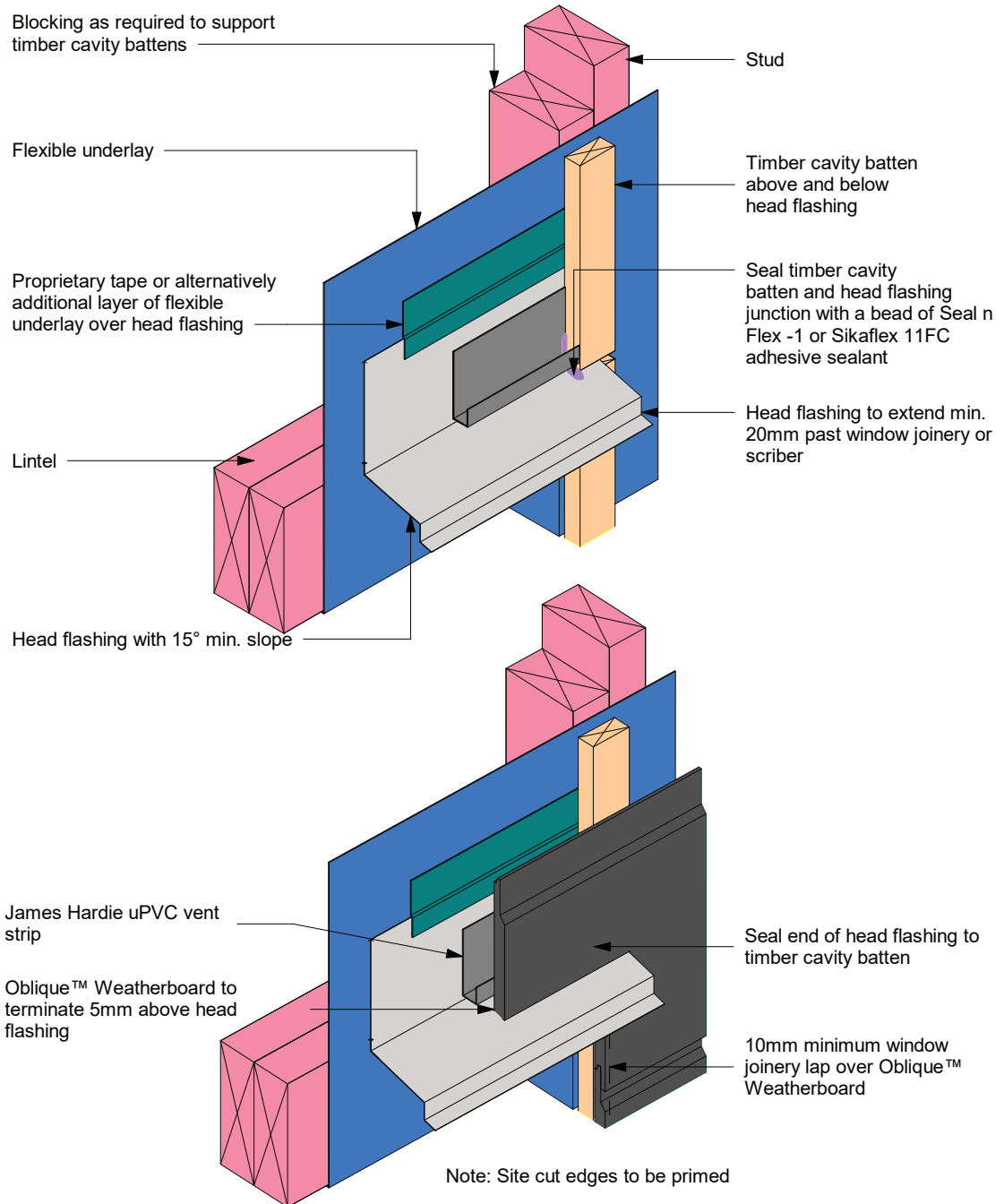

Figure 24: Window jamb flashing

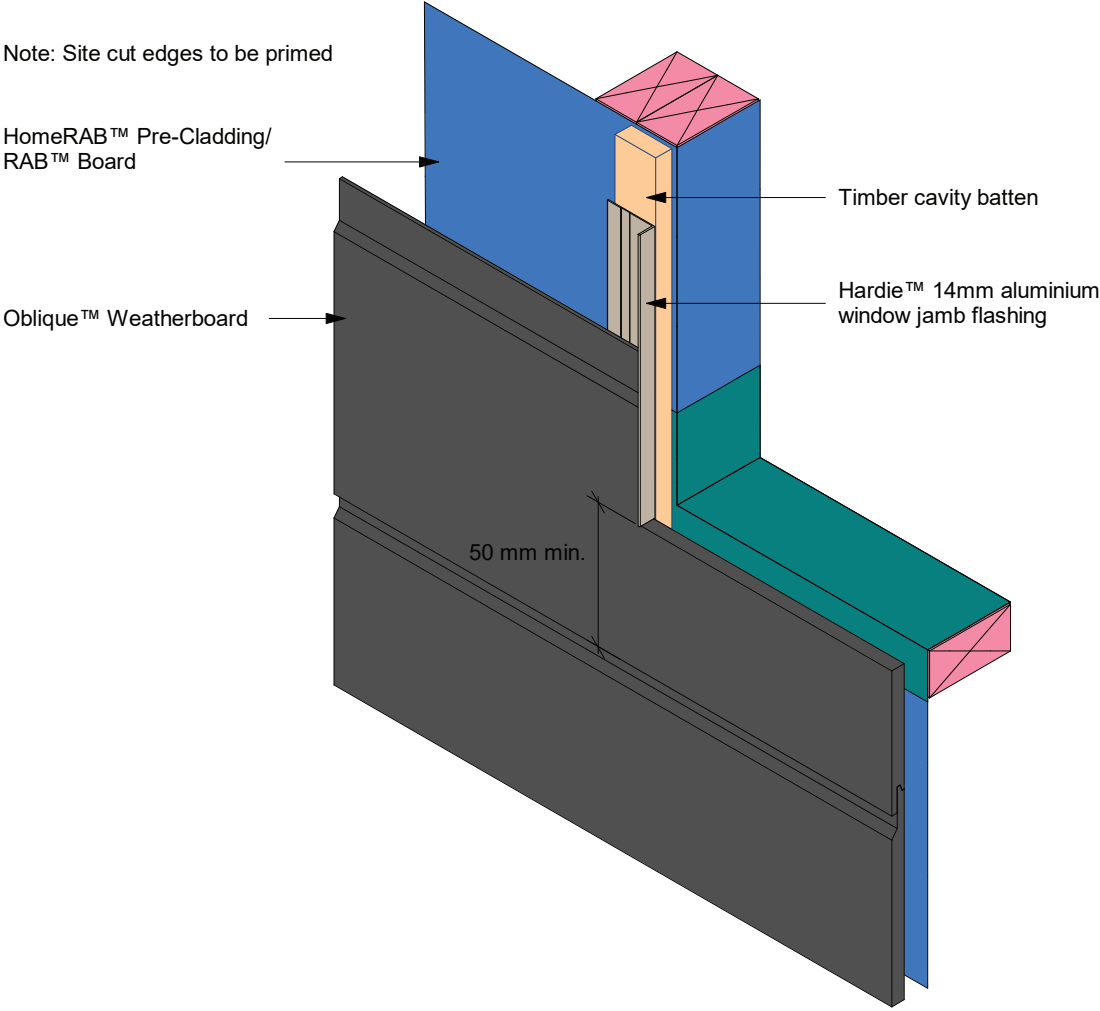
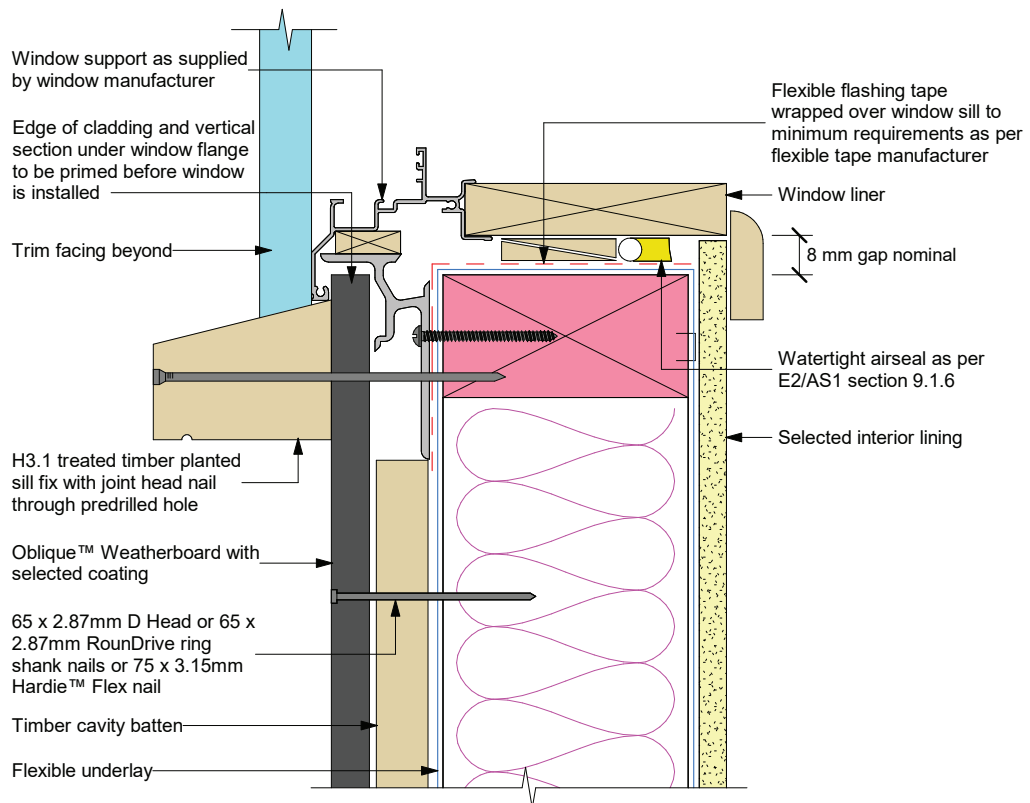

Figure 25: Window sill with facing



General notes for materials selection

1. Flexible underlay must comply with acceptable solution E2/AS1
2. Flashing tape must have proven compatibility with the selected flexible underlay and other materials with which it comes into contact

Refer to the manufacturer or supplier for technical information for these materials

Figure 26: Window jamb with facing

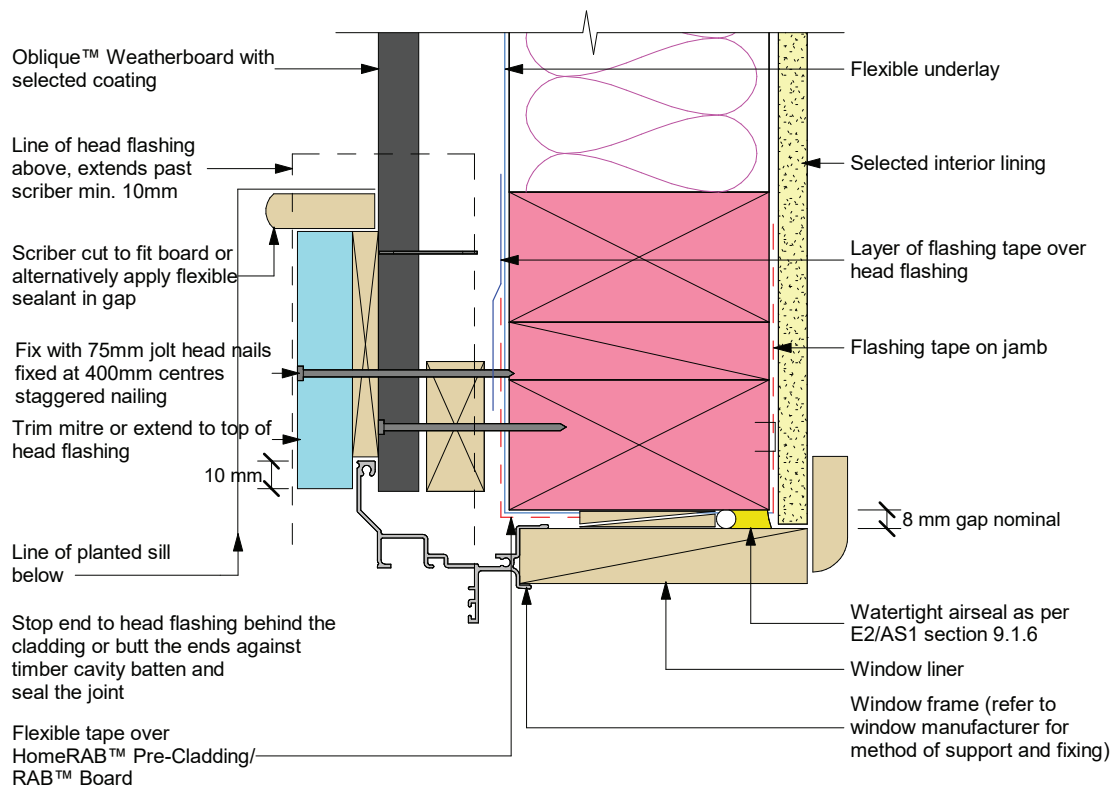

Note: Site cut edges to be primed

Figure 27: Window head with facing

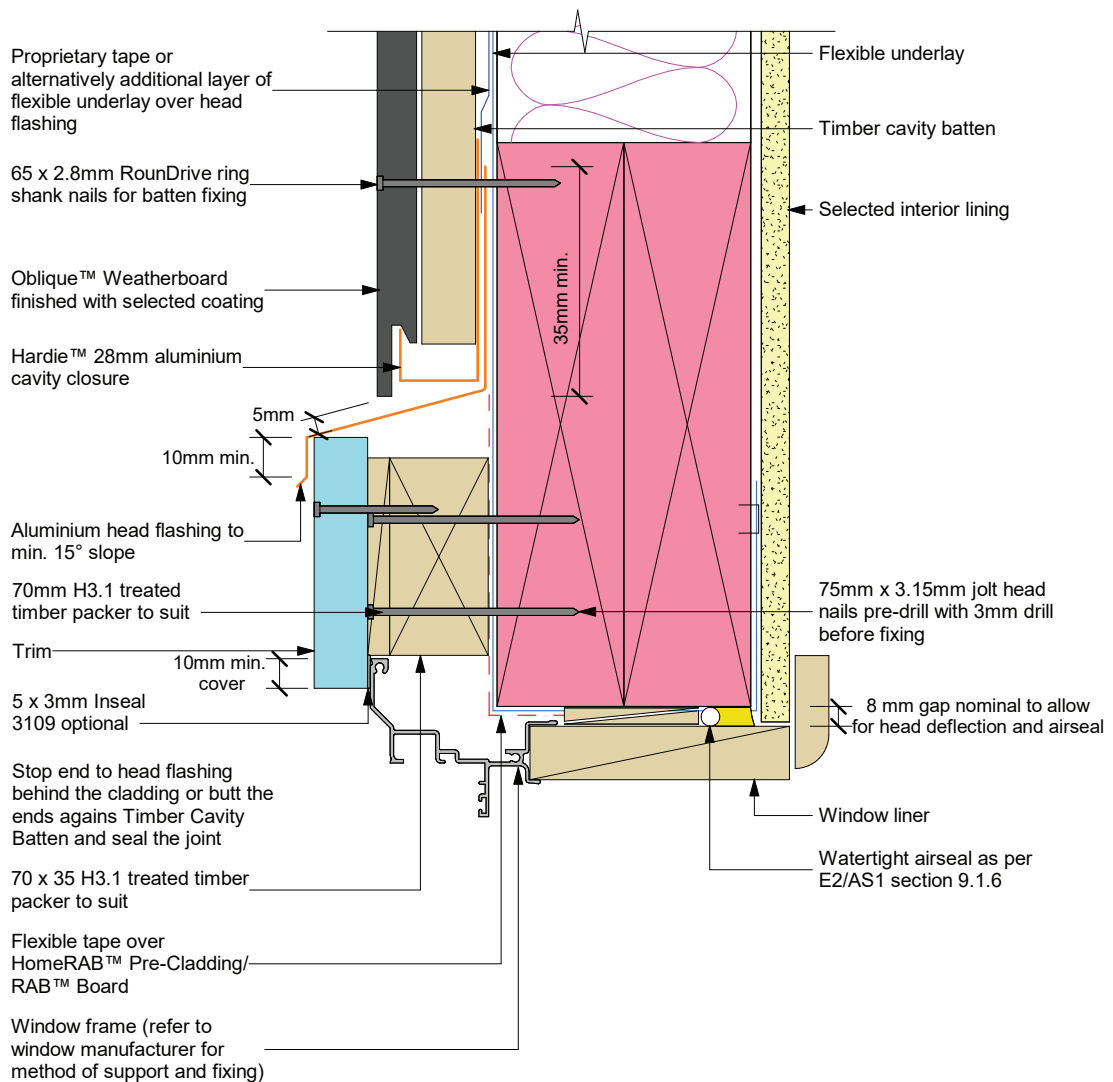

Note:

- Alternatively, the head flashings can be formed with stop ends as per E2/AS1
- Sealant must be installed between Trim and window flange in VH and EH wind zones and SED pressures

Figure 28: Door sill support detail

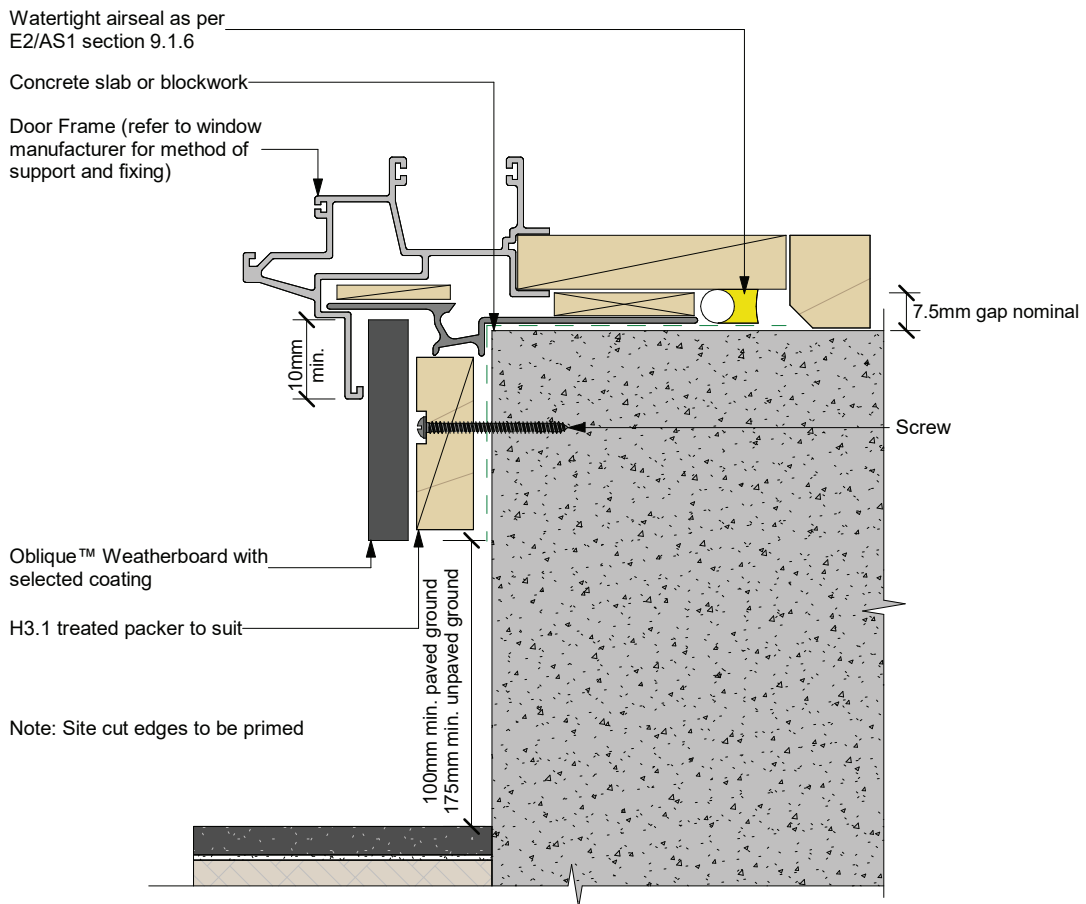

Refer to the manufacturer or supplier for technical information for these materials

General notes for materials selection

1. Flexible underlay must comply with acceptable solution E2/AS1
2. Flashing tape must have proven compatibility with the selected flexible underlay and other materials with which it comes into contact

Figure 29: Pipe penetration

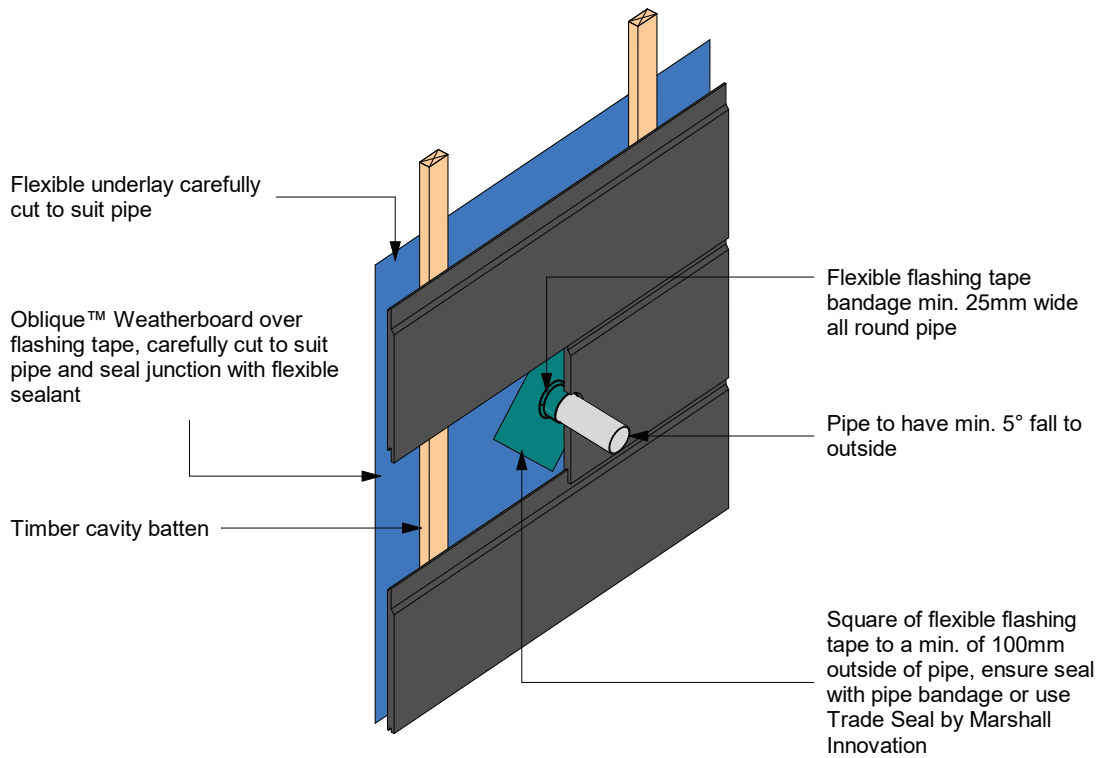

Note: Site cut edges to be primed

Figure 30: Trimline joint flashing at floor level

interactive assembly
instructions available
<http://wksp.nz/jh-lto-htrjfl>



Get WORKINGSPEC from
Apple App Store/Google Play

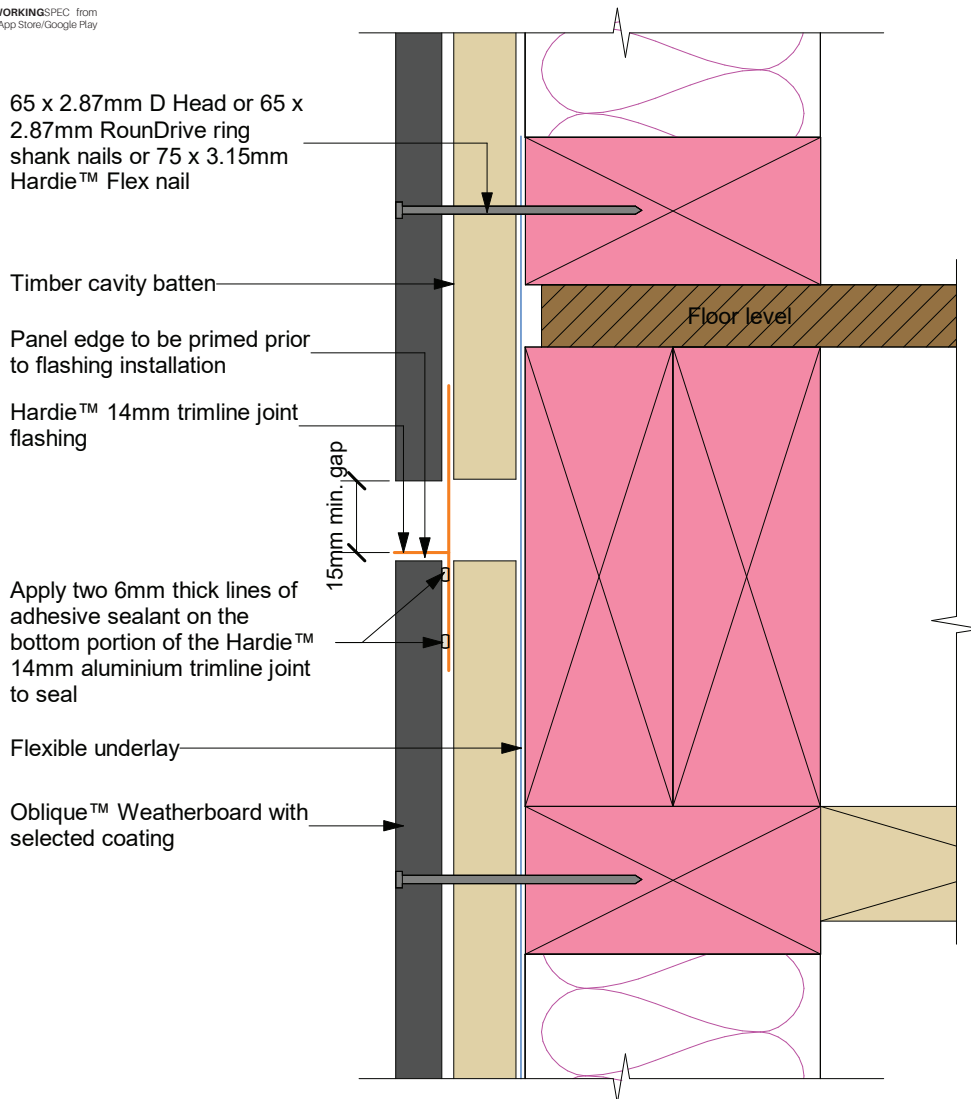

Notes:

- The flashing to be placed in the centre of the floor joists. Do not fix cavity battens or cladding into floor joists
- Hardie™ 14mm aluminium trimline joint, take care to ensure continuous seal is formed between panel and the trimline joint
- Trimline horizontal jointer 'L' shaped flashing will be required over the butt joint of the Hardie™ 14mm aluminium trimline joint
- Site cut edges to be primed

Figure 31: Continous cladding over joist at floor level

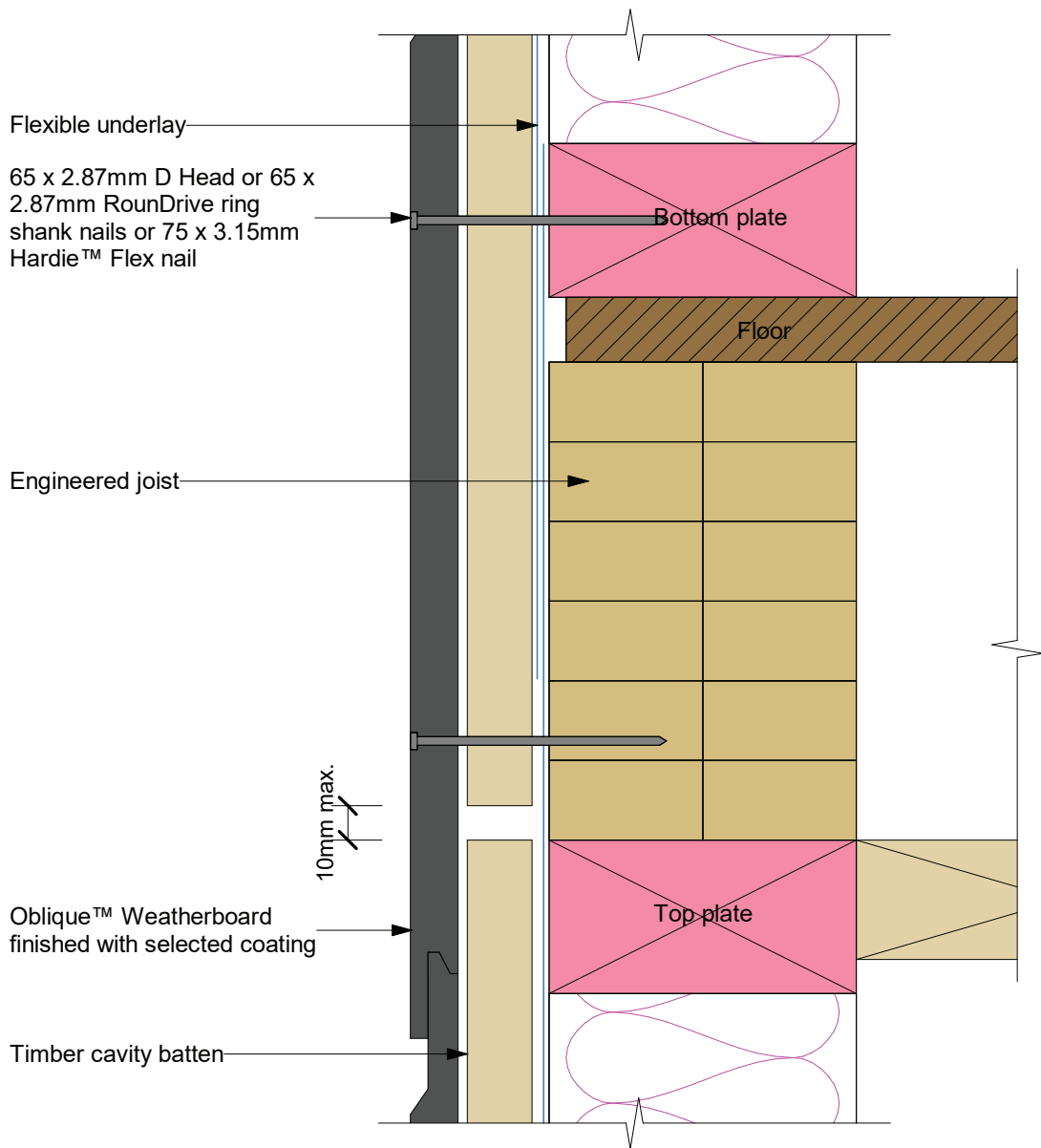
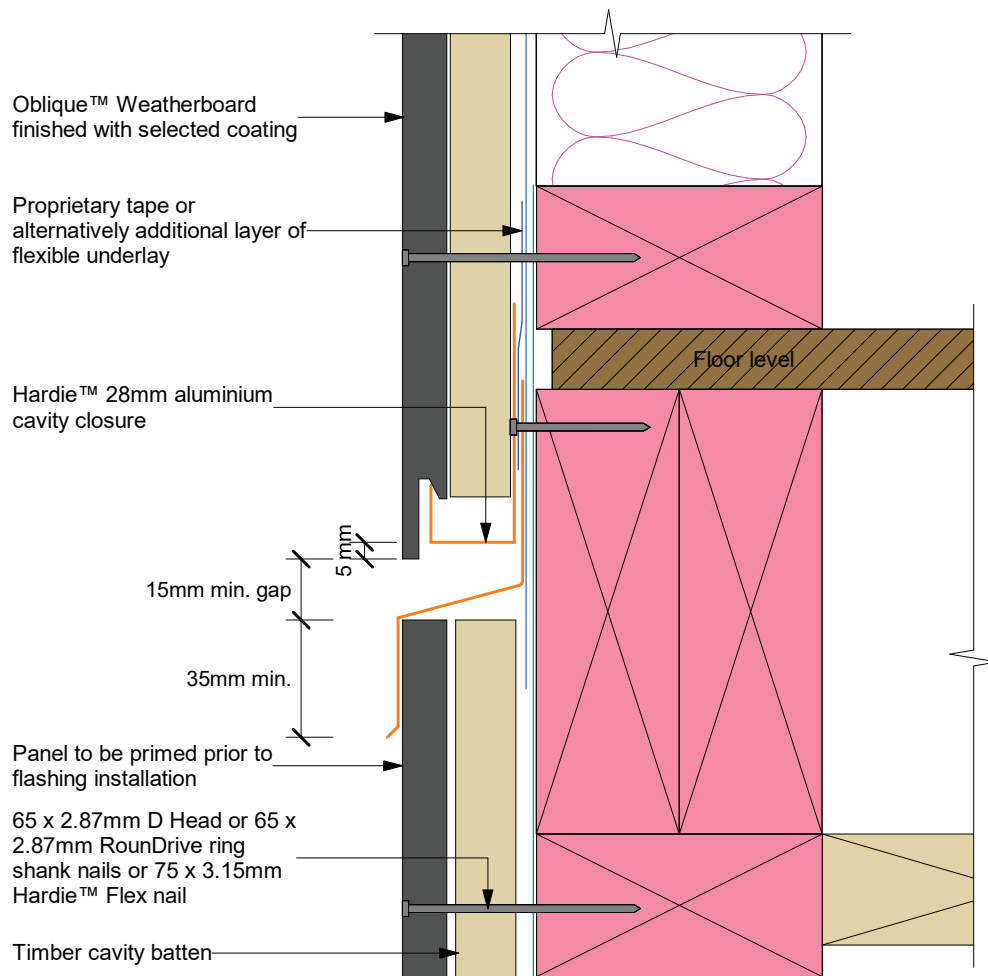

Figure 32: Drained flashing joint at floor level



Fk

Figure 33: Trimline joint flashing at external corner

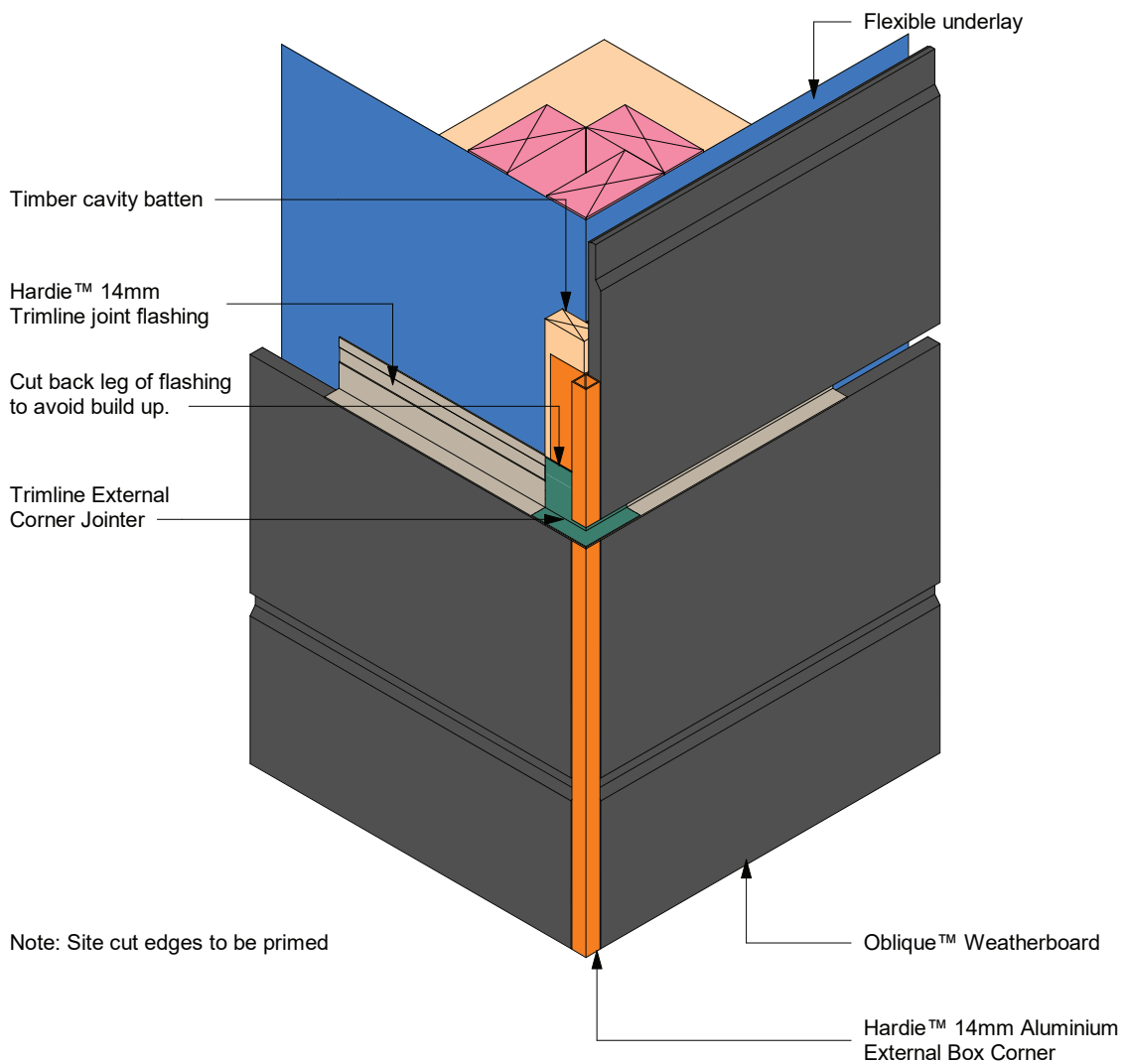

Figure 34: Trimline joint flashing at full external corner

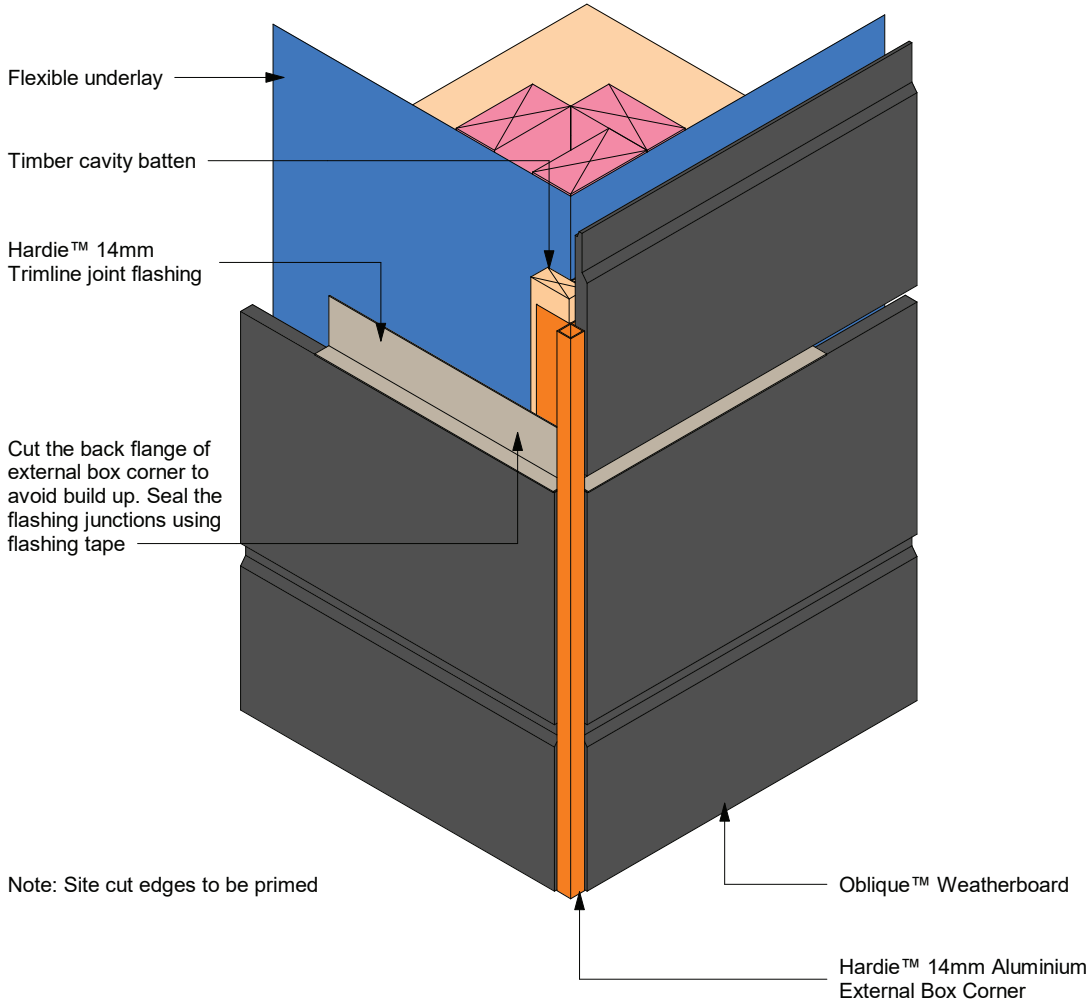

Figure 35: Trimline joint

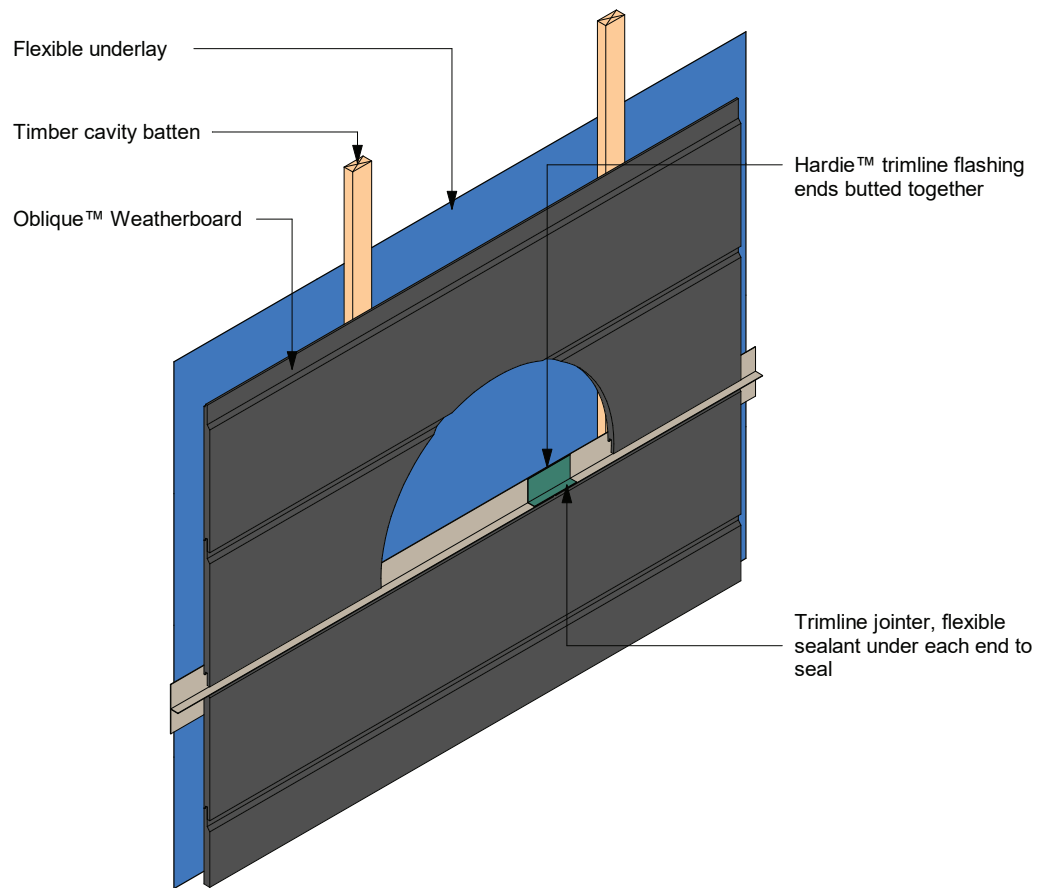

Figure 36: Trimline joint flashing at internal corner

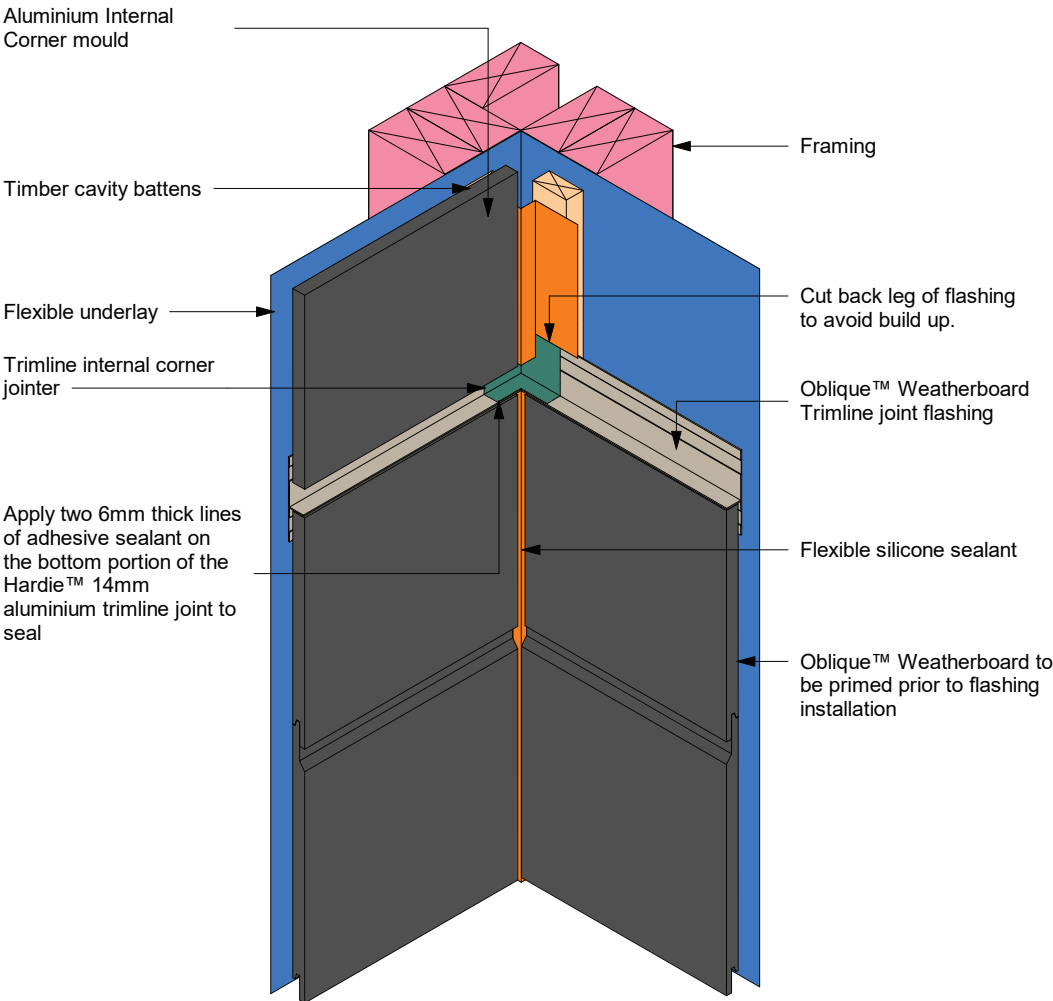
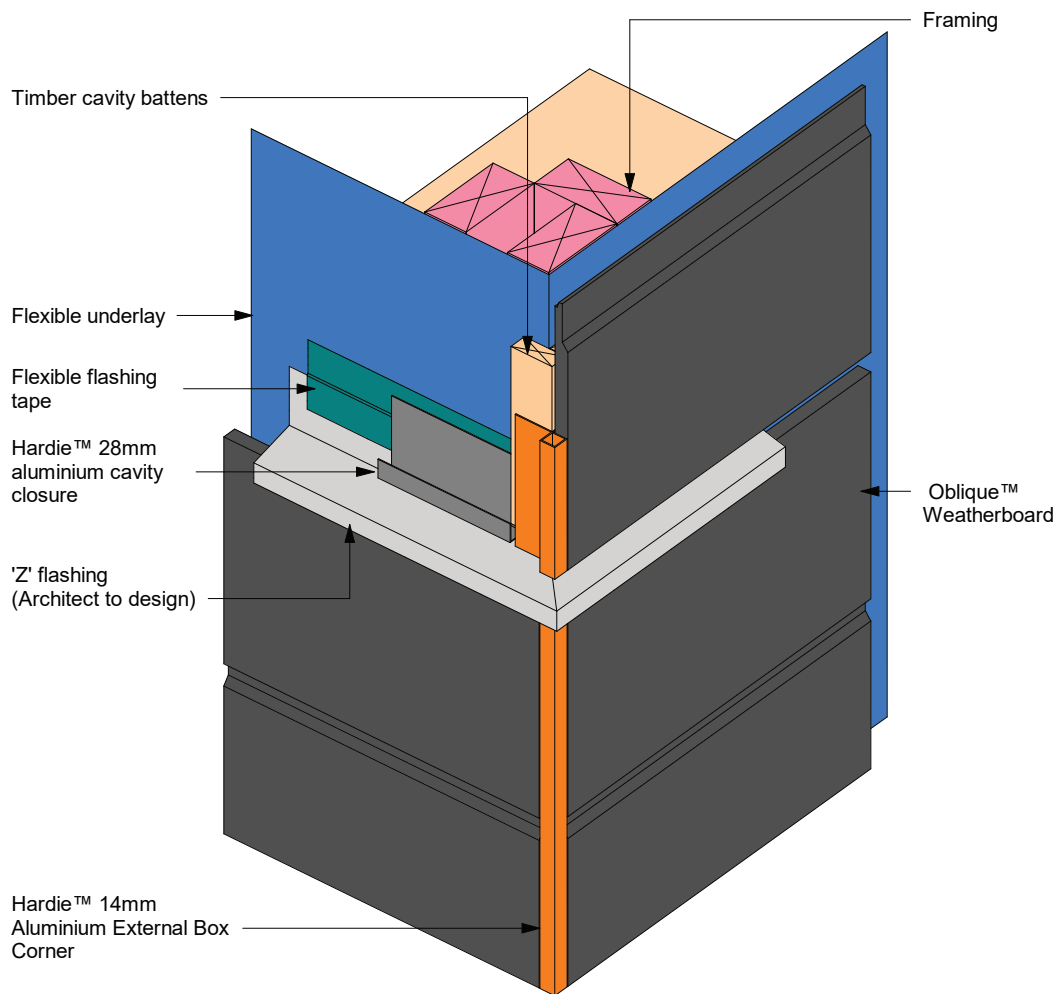

Figure 37: Drained flashing joint at external corner



Note: Site cut edges to be primed

Figure 38: Parapet flashing

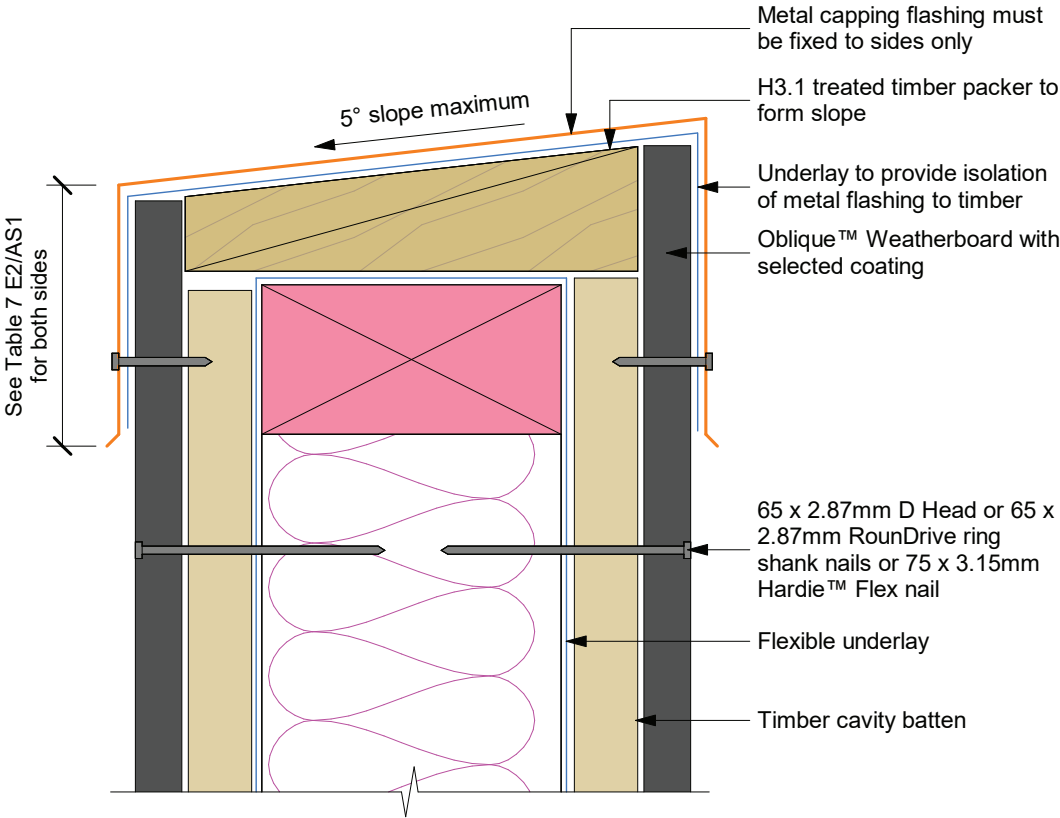
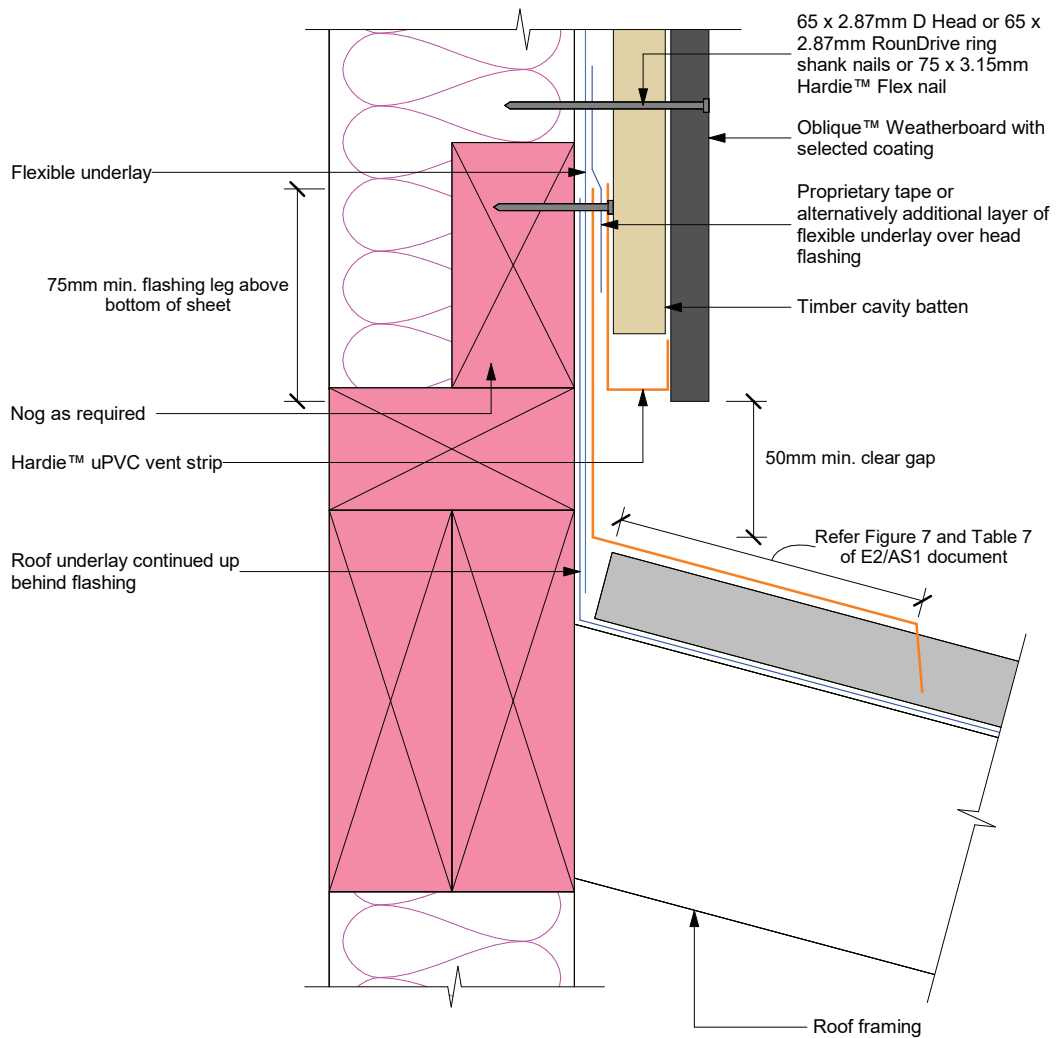

Figure 39: Apron Flashing detail



- Notes:
- When 50 year durability for flashing is required refer to Table 20 NZBC E2/AS1 document
 - Site cut edges to be primed

Figure 40: Roof to wall junction detail

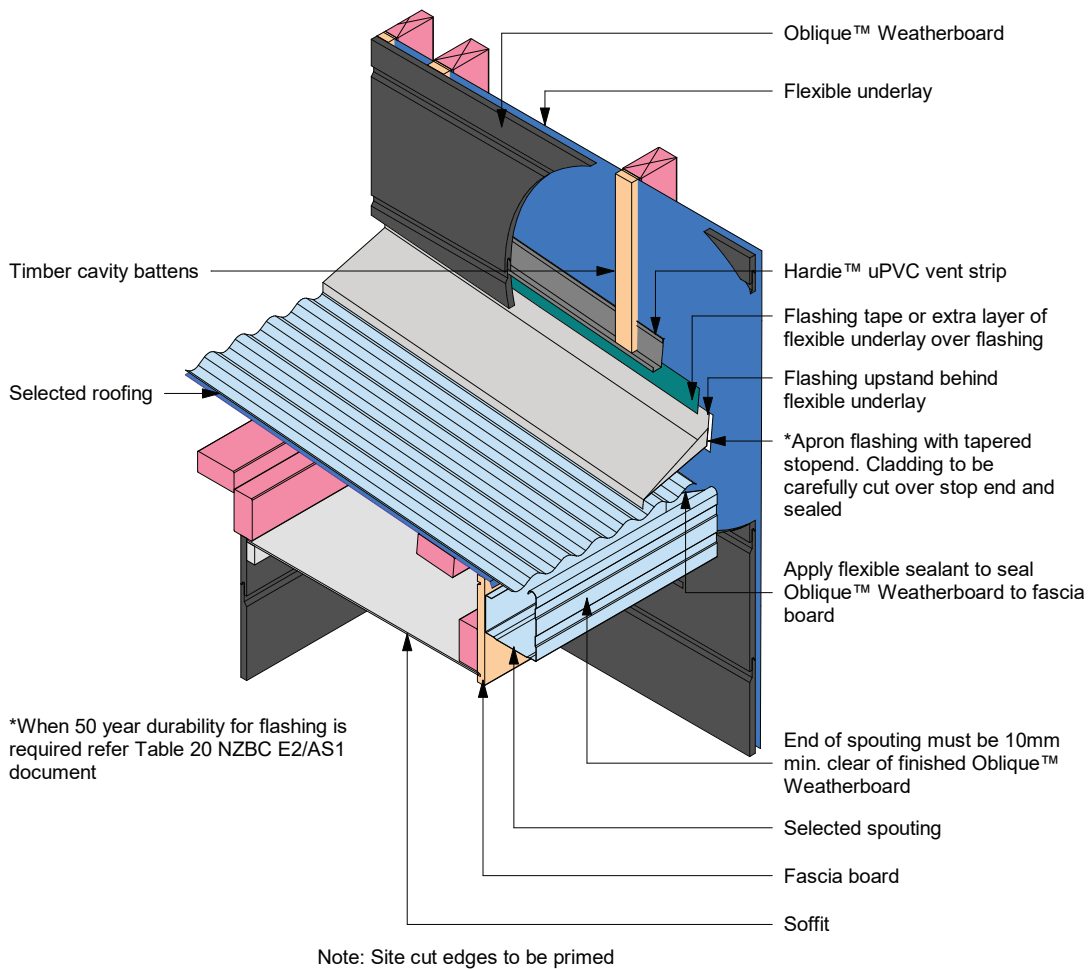
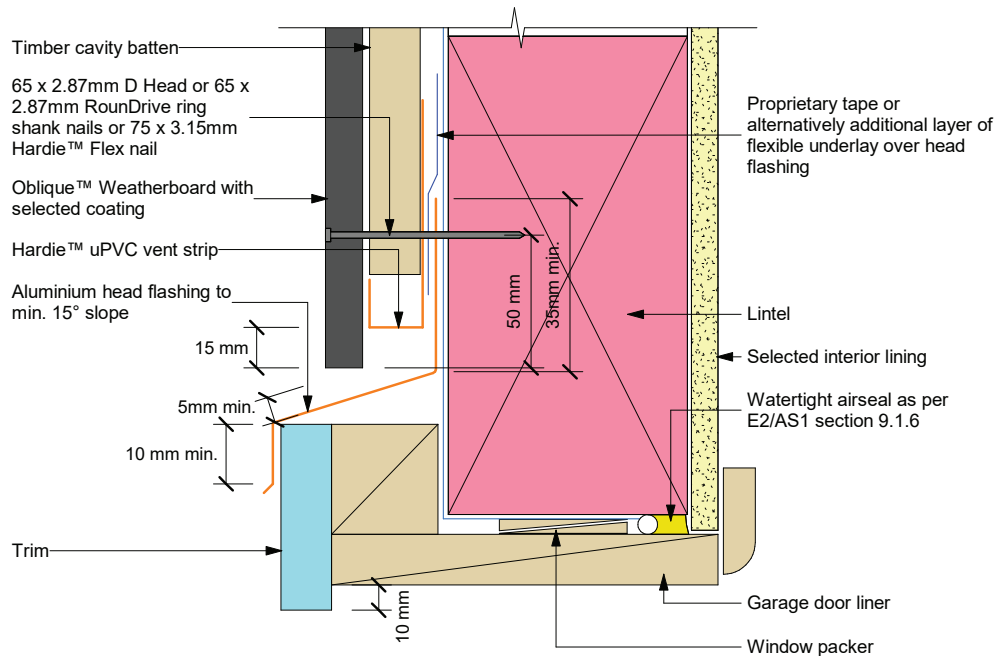
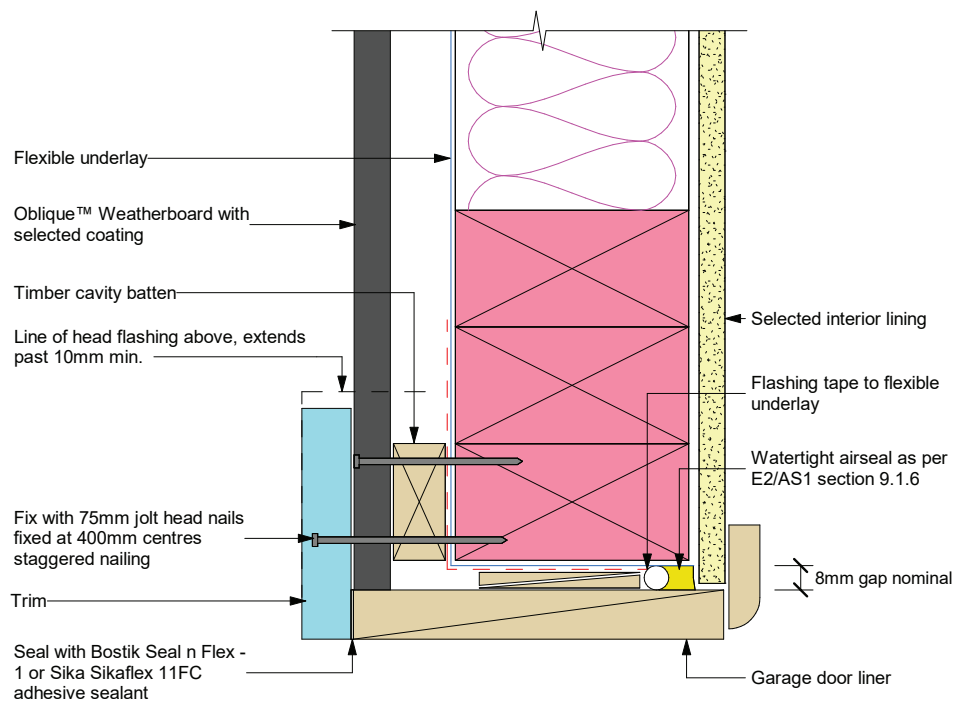

Figure 41: Garage head



- Sealant must be applied between head flashing and liner in VH and EH wind zones and SED wind pressures
- Site cut edges to be primed

Figure 42: Garage jamb



Note: Site cut edges to be primed

Figure 43: Cavity batten layout for heights over 10m

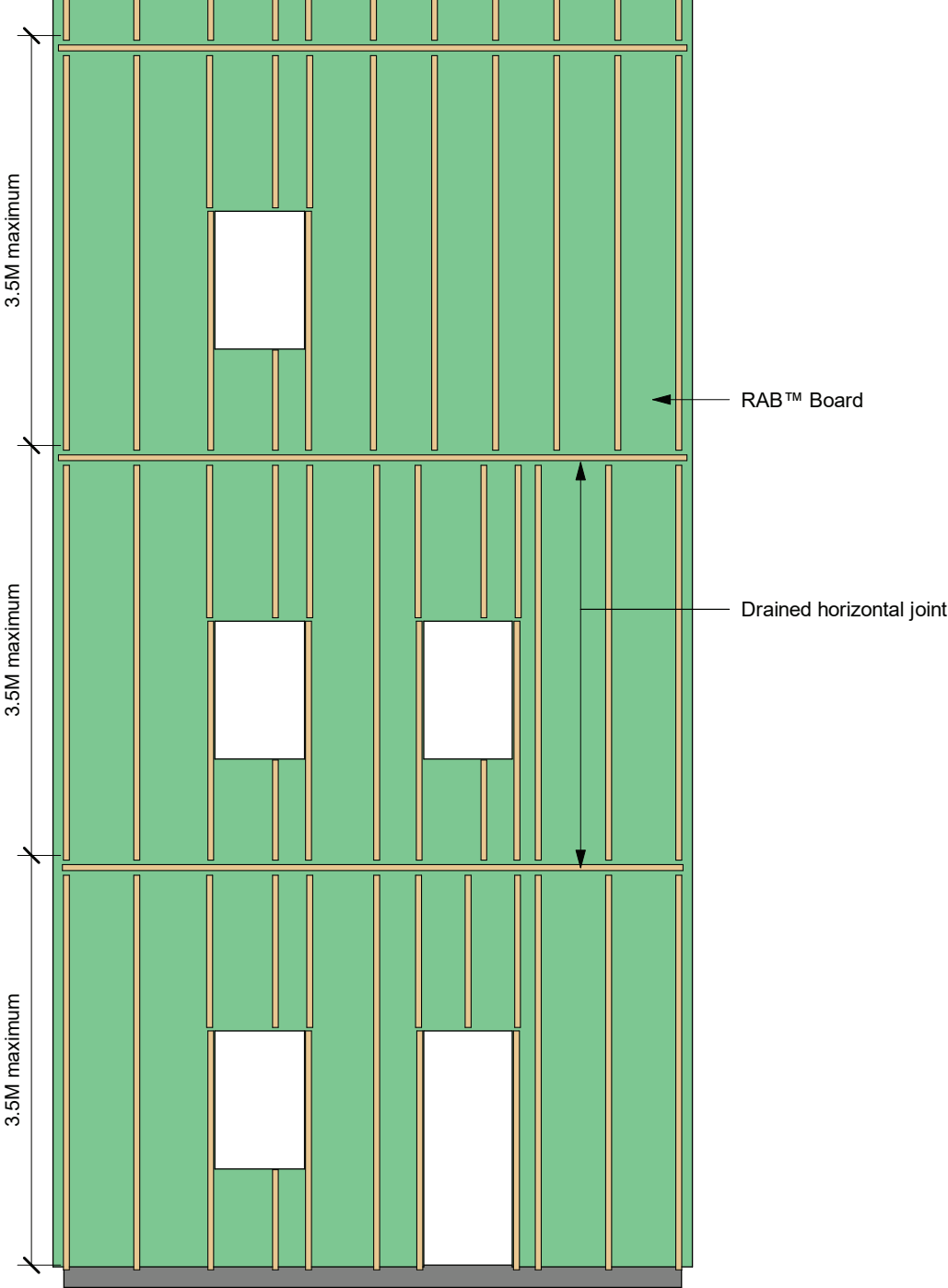
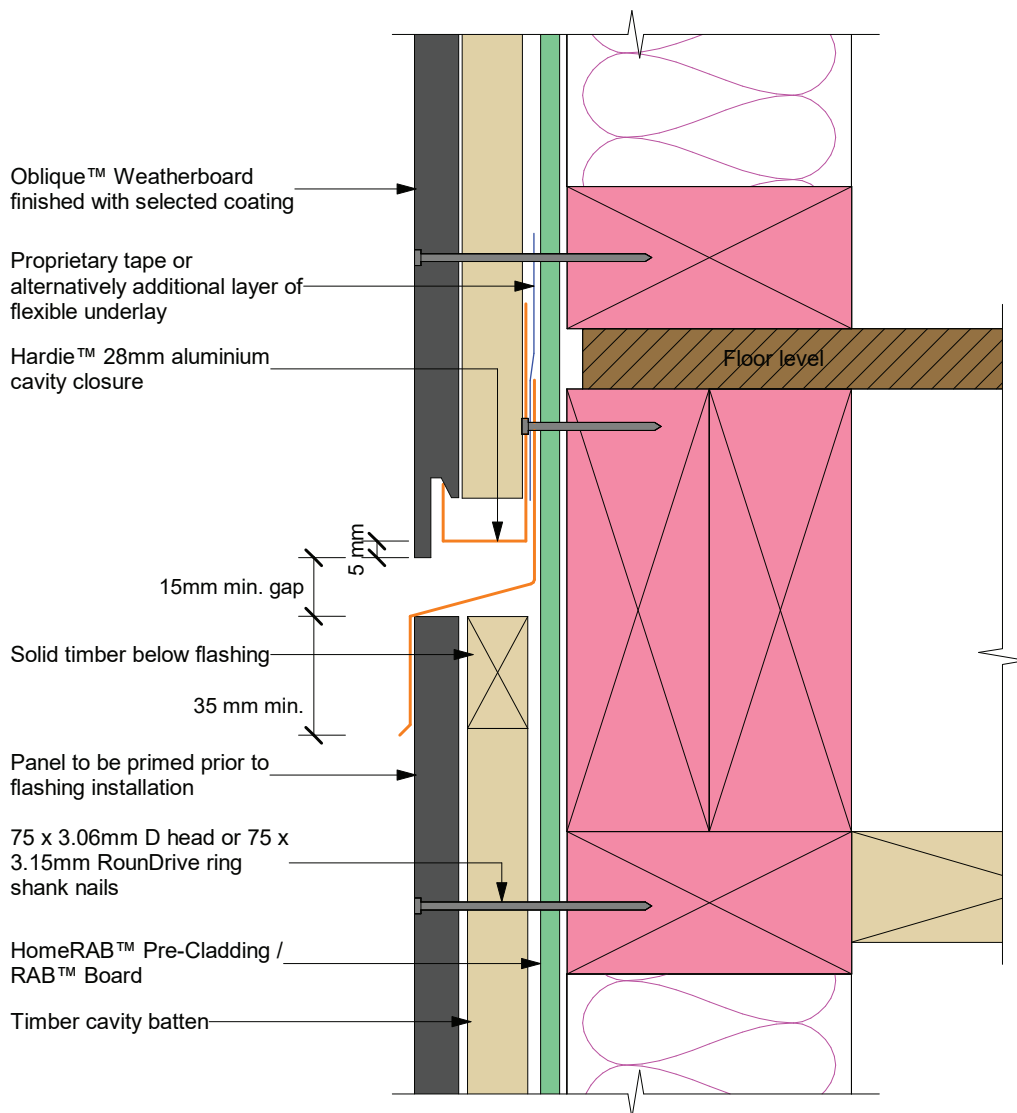

Figure 44: Cavity fire barrier for heights over 10m



Notes

- Check architect's plans for the type of flashing to be used
- Cut edges need to be primed
- When 50 year durability is required refer Table 20 E2/AS1
- The flashing to be placed in the centre of the floor joists. Do not fix timber cavity battens or cladding into floor joists
- This detail is required to limit cavities to a maximum of 2 stories or 7 metres. Refer to E2/AS1 clause 9.1.9.4

Product Warranty

James Hardie New Zealand Limited (“James Hardie”) warrants for a period of 25 years from the date of purchase that the Oblique™ Weatherboard on (the “Product”), will be free from defects due to defective factory workmanship or materials and, subject to compliance with the conditions below, will be resistant to cracking, rotting, fire and damage from termite attacks to the extent set out in James Hardie’s relevant published literature current at the time of installation. James Hardie warrants for a period of 15 years from the date of purchase that the accessories supplied by James Hardie will be free from defects due to defective factory workmanship or materials.

Nothing in this document shall exclude or modify any legal rights a customer may have under the Consumer Guarantees Act or otherwise which cannot be excluded or modified at law.

CONDITIONS OF WARRANTY:

The warranty is strictly subject to the following conditions:

- a) James Hardie will not be liable for breach of warranty unless the claimant provides proof of purchase and makes a written claim either within 30 days after the defect would have become reasonably apparent or, if the defect was reasonably apparent prior to installation, then the claim must be made prior to installation;
- b) this warranty is not transferable;
- c) the Product must be installed and maintained strictly in accordance with the relevant James Hardie literature current at the time of installation and must be installed in conjunction with the components or products specified in the literature. Further, all other products, including coating and jointing systems, applied to or used in conjunction with the Product must be applied or installed and maintained strictly in accordance with the relevant manufacturer’s instructions and good trade practice;
- d) the project must be designed and constructed in strict compliance with all relevant provisions of the current New Zealand Building Code (“NZBC”), regulations and standards;
- e) the claimant’s sole remedy for breach of warranty is (at James Hardie’s option) that James Hardie will either supply replacement product, rectify the affected product or pay for the cost of the replacement or rectification of the affected product;
- f) James Hardie will not be liable for any losses or damages (whether direct or indirect) including property damage or personal injury, consequential loss, economic loss or loss of profits, arising in contract or negligence or howsoever arising. Without limiting the foregoing James Hardie will not be liable for any claims, damages or defects arising from or in any way attributable to poor workmanship, poor design or detailing, settlement or structural movement and/or movement of materials to which the Product is attached, incorrect design of the structure, acts of God including but not limited to earthquakes, cyclones, floods or other severe weather conditions or unusual climatic conditions, efflorescence or performance of paint/coatings applied to the Product, normal wear and tear, growth of mould, mildew, fungi, bacteria, or any organism on any Product surface or Product (whether on the exposed or unexposed surfaces);
- g) all warranties, conditions, liabilities and obligations other than those specified in this warranty are excluded to the fullest extent allowed by law;
- h) if meeting a claim under this warranty involves re-coating of Products, there may be slight colour differences between the original and replacement Products due to the effects of weathering and variations in materials over time.

Disclaimer: The recommendations in James Hardie’s literature are based on good building practice, but are not an exhaustive statement of all relevant information and are subject to conditions (c), (d), (f) and (g) above. Oblique™ Weatherboard has been appraised by BRANZ as an alternative solution and found to meet the required provisions of the NZBC when installed in accordance with the relevant Oblique™ Weatherboard technical specification. However, as the successful performance of the relevant system depends on numerous factors outside the control of James Hardie (e.g. quality of workmanship and design) James Hardie shall not be liable for the recommendations made in its literature and the performance of the relevant system, including its suitability for any purpose or ability to satisfy the relevant provisions of the NZBC, regulations and standards, as it is the responsibility of the building designer to ensure that the details and recommendations provided in the relevant James Hardie installation manual are suitable for the intended project and that specific design is conducted where appropriate.

© 2024. James Hardie New Zealand Limited. TM and ® denotes a Trademark or Registered Mark owned by James Hardie Technology Limited.

